

Includes
Strike Commander
Technical Manual

SUDDEN DEATH

July 2011 Volume 12, Number 9

TL 12.00 Turk.

\$4.50 U.S.A.

£2.50 U.K.

Wildcats

Dossiers and a Typical
Mission

The Jackal Speaks!

Jean-Paul Prideaux's
Response

Gule Gule's Story

An SD Exclusive!

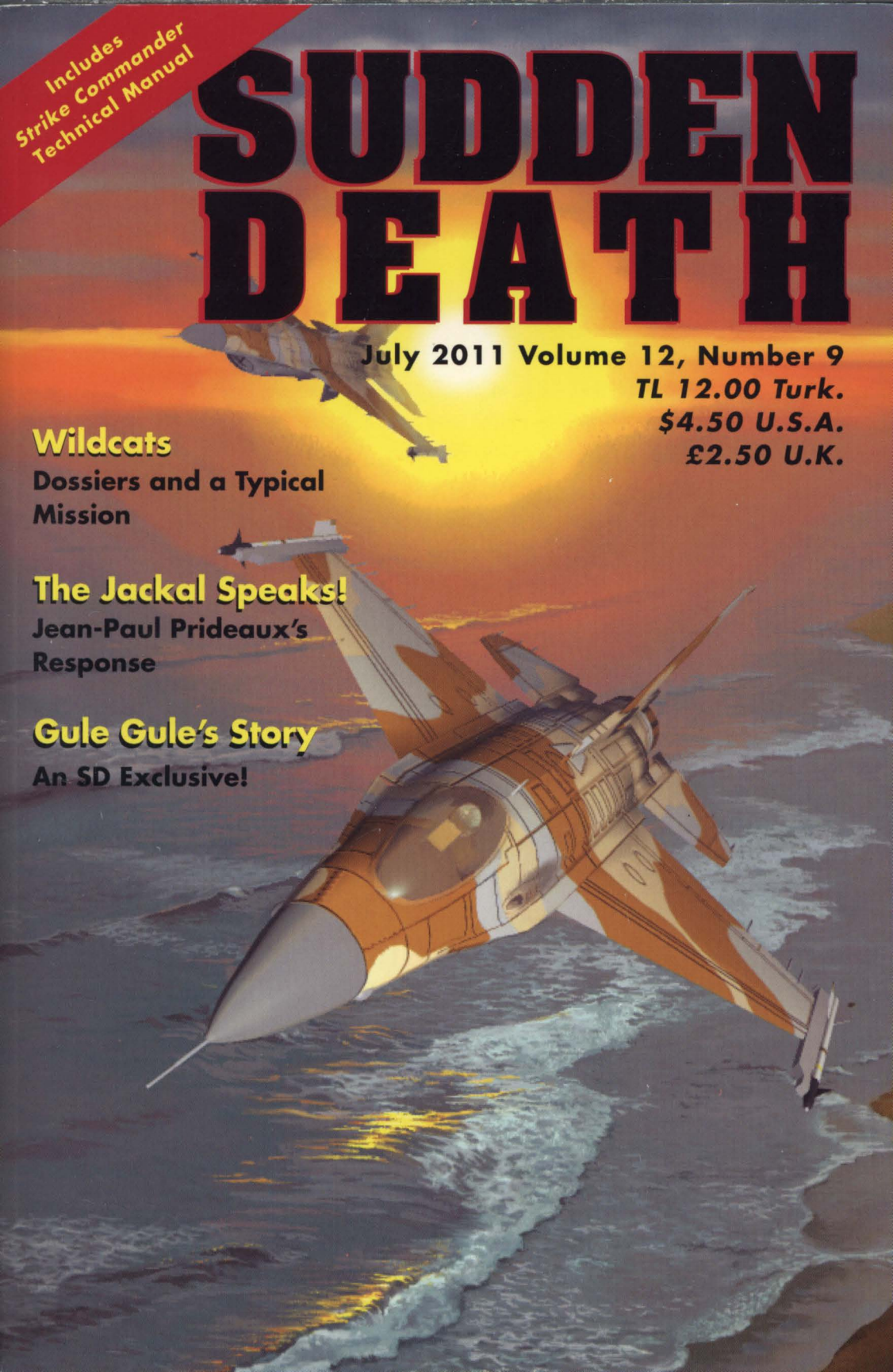

Editor-in-Chief

David Ladyman

Contributing Editor

Carolyn Cutler

Art Department

Craig Halverson, Bruce

Lemons, Danny Garrett,

Jake Rodgers and Chris

Douglas (photography)

Paul Steed (illustrations)

Eric Lund (diagrams)

Graphic Design

Jennifer Davis (interior)

Craig Miller (cover)

Senior Writer, Fiction

Gilbert P. Austin

Writer-Reporters

Tim Ray, Robert Irving,

Prem Krishnan

Chief of Correspondents

Chris Roberts

Special Correspondents

Jason Templeman,

Bill Baldwin, Paul Isaac,

Frank Savage

Foreign Correspondent

Erin Roberts

"Mission Accomplished"

Cover Photograph by D. Duhm,

using a Nactar 486.33. For more,

see "Sell and Scramble — A Typical Wildcat Mission," on page 12

C O N T E N T S

SUDDEN DEATH

July 2011 Volume 12, Number 9

2.....The Root of all Evil: Squadrons Fighting
and Killing to Stay Above Water
Editorial

4.....Mail Drop

6.....The Wildcats: They're Not Just a
Squadron, They're a Smart Venture
Virgil Beetlebaum

7.....Wildcat Dossiers

12....Sell and Scramble:
a Typical Wildcat Mission
D. Duhm

22....Contract: Terminated!
An Enforcer Speaks Out
"Gule Gule"

34....Investigative Report
"James Stern: The Untold Story"

36....Leader of the Pack: The Jackal Speaks!
An Exclusive Interview with Jean-Paul
Prideaux

40....Decade of Turmoil Winds to a Close

44....Want Ads

45....Play Guide

THE ROOT OF ALL EVIL

*SQUADRONS FIGHTING AND KILLING
TO STAY ABOVE WATER*

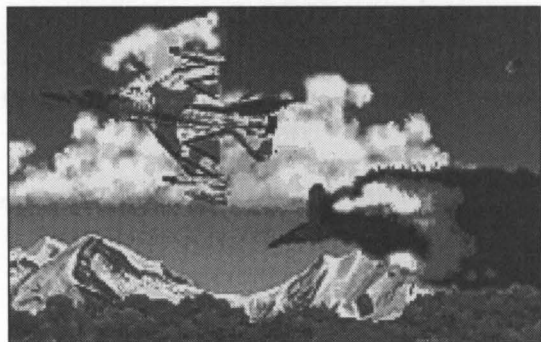

I was in Selim's on a Wednesday night, walking away from Jean-Paul Prideaux's usual table in the back (having just completed the interview with him you'll find in this issue), when I overheard the drunken murmurs of a Turkish official who shall remain nameless (I protect my sources, even inadvertent ones). According to this official, on 1 August Ankara will unveil a new "Turkish Diplomatic Forces Windfall Profits Tax" which will go into effect this coming fall. Under the terms of the new tax, set at 28% of applicable gross revenues, "windfall profits" would include kill bonuses, gratuities and *any profits in excess of 15% of monthly operating expenditures!*

This tax will devastate the premier industry of Turkey, hitting grunt and flyboy with equal force. While the grunt is fiscally nomadic, roaming wherever the money is and making less of it, his overhead is so minimal that putting a 28% tax on profits above 15% of his overhead effectively deducts another 28% from his total annual income. And though merc squadrons regularly deal in eight and nine digit figures, considering that most have overhead and maintenance costs ranging from \$10 to \$25 million American per month, an added 28% deducted from what little profit margin they accrue guarantees hard times ahead for even the high end of the industry.

This fact becomes more apparent when you consider the escalating cost of insurance premiums. Recent industry studies reveal that, out of twenty-seven Istanbul-based merc squadrons, twenty-four lease jets from outside agencies. Given the risks involved to aircraft in any merc operation, insurance never comes cheap. The three squadrons who can afford to own their own fighters don't need full coverage, but the rest are milked dry, sometimes paying in premiums more than they'd pay monthly to purchase the planes outright (if only they could get such credit extended to them!). The situation only worsens as the merc industry grows, and more planes are

destroyed than ever before. Even without this new tax, squadrons would have been hard-pressed to survive. Now, the solvency of most squadrons will be tested to an unprecedented extent.

This couldn't come at a worse time for mercs. The economic doldrums hanging over Istanbul these past few months have led to an increase in violence across the board. Mercs turn to Wiz or RNA out of boredom or frustration, then sanction civilians to feed their habits. Employers, encouraged to daring by the chaos in the streets, are defaulting on payments, instigating bloody vendettas that leave dozens of innocents dead (and all too often, the offending target isn't among them). The proposed new tax will only exacerbate this release of aggressive energy, so much of which used to be focused along, if not peaceful, at least profitable lines. Mindless destruction seems to be the order of the day, an irreversible downward spiral. Or is it?

In this issue we examine the unique squadron bucking this bloodthirsty trend — Stern's Wildcats. Under the leadership of Commander James Stern, the Wildcats accept missions based as much on morality as profit margin, rejecting outright murder even when the dollar stakes are high. The questions I raise in this issue include: are the Wildcats a fluke, or the future? In light of the violence around them, considering the new windfall profits tax, will the Wildcats sink or swim? And will other squadrons follow?

And what about the Jackals, the squadron Jean-Paul Prideaux founded when he broke away from the Wildcats four years ago? Their philosophy is somewhat more traditionally mercenary, Prideaux caring little how a mission weighs in on the cosmic scale so long as it balances in the checkbook. The Jackals' annual profits are now three times those of the more idealistic Wildcats. What does this say about the future of mercenary philosophy? We'll examine both approaches in this issue, and leave the decision to you.

— GPA

I've got to correct the terrible injustice inflicted on fixers by your recent article "Fixing the Fixers" [Volume 12, Number 7, May 2011 — Ed.] Really, gentlemen, it would be terrible if anyone in the merc business swallowed that garbage, and not just for hard-working job brokers like me. Sure, lots of squadron leaders in Istanbul would like to believe they could get along without fixers finding them work, but you're not doing them any

favours by encouraging this unrealistic thinking. Fact is, what small fee percentage they might save by "cutting out the superfluous middleman" would be offset by the trouble, even danger, of seeking out their own jobs.

Fixers don't just sit in seedy bars, chasing muffins with tequila shots and getting fat. That's just the nice part of the job. When we're not in the bars, we're nosing around the Old Quarter, pinching our nostrils against the throngs of the unwashed, stepping over bodies in filthy alleys to take meetings, and bribing contacts for news of work. I don't have to tell you that, moving through the Istanbul underworld as we do, we frequently run up against the business end of a shiv or the barrel of a Smith & Wesson. Sometimes you're just in the wrong place at the wrong time, and the bullet whizzing toward your head is "nothing personal." Other times, a competitor is on the same job trail, and that same bullet comes with bad intentions. Either way, you can wind up just as dead.

So, do everyone a favor and stop trying to sell that sick puppy. It ain't gonna hunt.
— "Beto"

[P. Fisch, the originator of the article, responds as follows: "Although in many cases fixers make it easier for lazy squadrons to find work, they are by no means vital. The energetic entrepreneur can get as much work as any fixer. I stand by my article." — Ed.]

You bastards got a lot of nerve. Last July I laid out a hell of a lot of money to place a "Work Wanted" ad in the back of your dam [sic] magazine. Three months went by, and I didn't get no replies. This really pisses me off. And I'm the wrong guy to do that to. I spent the rent money on that ad, hoping I'd recover the loss with the business your rag would bring me, but nothing came and I got throwd [sic] out on the fraggin' street. Lemme tell you, squattin' on the 'creeet has done bad things to my temperment [sic]. I been hustling up just enough money doing migrant snuff jobs to keep my A-10 in a hangar, and I got one final Paveway I been saving for a rainy day. All I got to say is, you refund my money, cause I really need it, or else I'm gonna slam that Paveway right into your ****ing editorial offices.

— "Dissed"

[I'd like to remind all potential advertisers that in no way does SUDDEN DEATH guarantee that any advertisements placed within our pages will achieve the desired result. Furthermore, "Dissed" would do well to keep his Paveway to himself. The editors of SUDDEN DEATH employ their own mercenary squadron, the G-Men, to protect the home office. And they fly F-18 Hornets. In light of this fact, the chances for an A-10 surviving an approach toward our airspace would be... slight. Ed.]

Given that many mercenaries are, through no fault of their own, generally ignorant of international tax law, I just wanted to warn your readership about the screwing they can expect if they operate within United States territory.

Every squadron flying out of Turkey expects to pay the so-called "umbrella tax" in exchange for the TDF [Turkish Diplomatic Forces — Ed.] designation. It is this designation that permits us to fly offensive missions against targets in foreign countries with immunity (at least on an official level), and a percentage of our income for that protection seems

reasonable to most squadrons. But the problem comes when you fly a strike against a target within "official" U.S. territory (including those states that have seceded from the union — even though these secessions are fait accomplis, the U.S. government fails to recognize them).

Whenever a squadron conducts business in the U.S., U.S. forces ignore the incursion into their airspace, but IRS accountants do not, and then come January or February you can expect to receive a bill in the mail. It will be a notice from the IRS demanding you pay taxes on the profits you accrued from destroying property within U.S. borders. In other words, the U.S. government will allow you to trash the private property of U.S. citizens, provided Uncle Sam gets a piece of the pie!

This is extortion, pure and simple. Naturally, you may say, "What difference does it make whether I pay or not? I operate in Turkey, and to hell with them. Let them do their worst." That's what I said, anyway, and boy was I wrong. At roughly 600,000 employees (including accountants, auditors and soldiers), the IRS is currently the largest terrorist organization in the world. Not even the strongest squadron can hope to stand against them if they decide to make an example of you. They'll either assault you themselves, or hire the work out. My squadron, the Trogs, was wiped out during a nighttime raid involving two other mercenary squadrons, the Jackals and the Vipers, under IRS sponsorship.

The U.S. may be broke, but the IRS is rolling in the green stuff, smackers they are willing to part with for a little retaliation, bucks that sleezeballs like the Jackals are all too eager to grab for a little dirty work. May Prideaux rot in hell for what he did to us.

As things stand now, I'm flat broke and in hiding. I'm the sole survivor of that raid, and true to form, the IRS has put out a contract on my life. But I wanted to warn your readers: don't let this happen to you.

— "Hunted"

[Actually, we're working on a feature for next month's issue regarding the global predations of the dreaded IRS. Everything "Hunted" says is in fact true, even understated, and readers would do well to think twice before operating in the U.S. Furthermore, SUDDEN DEATH as a matter of policy frowns upon squadrons that shaft other squadrons. During the interview with Jean-Paul Prideaux of the Jackals presented in this issue, I referred to this case and asked him how he could justify this action. He pulled a thick wad of twenty-dollar bills from his pocket and grinned. Then he asked me where the letter from "Hunted" was postmarked from, explaining he hated to leave any job unfinished. Although I withheld the information, by the time I made it back to my office I found that my desk had been ransacked, and the letter was missing.

"Hunted" would be welladvised to change locations at the earliest possible opportunity. Ed.]

I'm really worried that more and more MNCs [Multinational Corporations — Ed.] are getting their own in-house squadrons. What impact will standing air fleets have on the mercenary market? Does this mean they'll start flying their own inter-corporate strikes, cutting Istanbul out of the loop entirely?

— Mark Gregory
4805 Finley Caddesi
Stamboul, Istanbul, Turkey

[Not at all. MNCs are acquiring F-15 and F-16 squadrons strictly for on-premises security. The simple fact of the matter is, it's more cost-efficient for MNCs to hire out hazardous offensives to professional squadrons. It makes sense for a corporation to hire a squadron for \$15 to \$20 million, when that corporation might lose several \$20 million jets in an independent action. Feel better? Ed.]

THE WILDCATS

THEY'RE NOT JUST A SQUADRON, THEY'RE A SMART VENTURE

Editor's Note: Although this piece was originally slated as an overview of how the Wildcat Squadron operates, Mr. Beetlebaum insisted on writing the article himself. SUDDEN DEATH agreed to this stipulation in exchange for his help in coordinating interviews with the various members of the squadron, background information, base passes and so forth. It is my opinion, however, that Mr. Beetlebaum has turned this supposedly objective article into a shameless plug for his squadron. For a more dispassionate view of the Wildcats, please see the article "Sell and Scramble — A Typical Wildcat Operation" elsewhere in this issue.]

When you hear someone mention the Wildcats, what do you think?

Do you think of the fact that, for six years, the Wildcats have provided consistent, professional service to those in need of armed assistance both locally and world-wide?

Do you consider the fact that the Wildcats fly only the finest aircraft, a squadron of top-flight F-16s, maintained in perfect condition at considerable expense, in order to best serve you?

Do you realize that the Wildcats have an operational success rate of 86%, a full 22% above the Istanbul Mean*?

Do you understand that the confidentiality of every job we take on is 100% guaranteed?

Or, when you hear someone mention the Wildcats, do you get hung up on the word "morality"?

Let's look at the facts:

It's true that of all the squadrons in Istanbul, the Wildcats alone have a reputation for turning down missions based on moral considerations.

• *But that's not all we're about!* Our pilots are the most experienced, blood-thirsty, savage aerial fighters in all of Istanbul! Just one look at our kill ratios should set your mind at ease about that. Our commander, James Stern, has flown combat missions in over a dozen operational theatres. In fact, all of our pilots must have flown campaigns in at least two theatres before they are considered for enlistment in the Wildcats.

• *We get the job done!* Unfortunately, many of you potential employers are reluctant to approach us, put off by our reputation as a "moral" squadron. Please believe me, you'd be doing yourself a terrible disservice by passing us by without a look at our facilities and the services we offer. No mission is too big, or too small, and we are always willing to listen to any business proposition. Don't walk away from us, driven by a prejudice about the kind of missions we might or might not take. Let us worry about that. As the Wildcat's accountant, I assure you we'll bend over backwards to find a way to accept even the dirtiest job!

• *We care about you!* We Wildcats are so confident about our ability to fulfill your mission needs, we have one of the lowest EL [*Extraordinary Losses — Ed.*] clauses of any Turkish squadron! Why should you pay through the nose if we screw up? Think of it — no more holding your breath wondering how many of the hired help will make it back from a sortie. When you fly with the Wildcats, you fly with confidence!

• *We need you!* Sadly enough, our operational resources can only benefit you if you give us a try!

• *You'll be glad you did!*

[* Istanbul Mean is based on a questionable survey commissioned by Mr. Beetlebaum himself — Editor]

WILDCATS DOSSIERS

MIGUEL SCHRAEDER, "ZORRO" — PRECISION PERSONIFIED

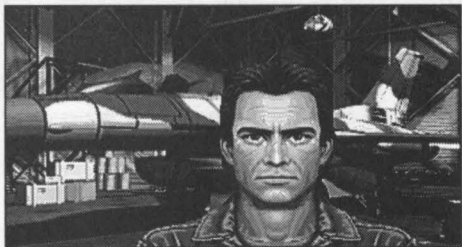

"I guess I earned the name Zorro for two reasons. One, I used to fight bulls as a teenager growing up in Barcelona. And the other reason is, I am so accurate in the air. I am as adept with missiles as the legendary swordsman was with a blade. Both attributes, I think, spring from the same talent. Nerves of steel." Capt. Schraeder flashes one of his rare smiles. "But, I could be wrong."

His teammates are quick to assert that Miguel's claim to iron nerves is not simple macho exaggeration. A veteran of the intense, close-quarter dogfighting that characterized the Central American Bloc Conflict of 2005, Miguel knows how to bring jets down quickly and efficiently. "I do not waste a lot of ammo as many do, spraying it across the sky and hoping I get lucky. I know only too well I may be praying for a full Vulcan when I run into more bogies later on. Likewise, when I launch a missile, it is only because I know in my heart that it will hit. I never launch when an enemy has even a slim window of escape. When I launch, that means one more plane is dead. I don't even waste time looking back to confirm

the kill." He rubs at the stubble on his chin thoughtfully. "That is just how it is. I do not even think about it anymore. But it is peculiar, is it not?"

More peculiar is the mix of fire and ice that forms the temperament of this extraordinary pilot. Proud, violent eyes peer out from Miguel's dark face, a pale scar across his right cheek, yet despite this dangerous visage, his voice is deceptively soft, even pensive.

"He's seen too much," says Col. Stern of Schraeder. "He's more than paid his dues." Stern refused to elaborate, but it's a safe bet those dues include the 18 months Schraeder spent in a Nicaraguan POW camp when his *Tomcat* was shot down over the dense jungles of Central America. Perhaps this further explains Schraeder's ongoing obsession with Latin American politics.

"Yes, I am known as the Wildcat's token 'political junkie,' whatever that is. I do not see how anyone can not be interested in politics, considering everything is political. I have a terrible feeling the next big hotbed of international conflict is going to be in Central-South America. But, of course, no one is reading the signs. You watch Nicaragua, Brazil, Peru, maybe Andes Mallorca — they are all headed for trouble soon." When asked if that wouldn't at least be good for business, Miguel's eyes burned angrily.

"That kind of business I can do without."

One can't help but feel Miguel speaks from experience.

LYLE RICHARDS, "BASELINE"

— MYSTERY MAN

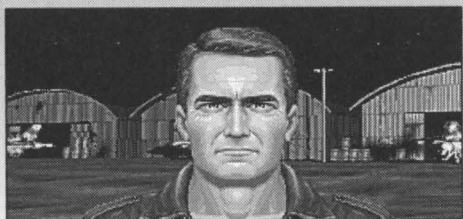

Lyle Richards, a 38-year-old veteran of several U.S. campaigns, has a reputation as a quiet, pensive man, so it came as no surprise when he declined our request for an interview (despite the fevered objections of the publicity-hungry Mr. Beetlebaum). For this reason, our information on Lt. Col. Richards is limited to what we could obtain from official U.S. Navy records.

A pilot of great skill, Richards initially honed his abilities aboard the *USS Saratoga*. Early reports in his dossier described him as "eager, enthusiastic, intelligent — committed to a military career — a keen interest in travel and knowledge of foreign cultures — ideal officer material." He attained the rank of lieutenant colonel before the *Shiloh* disaster, after which he left the Navy, presumably sharing his commander's disillusionment with the military establishment following the senseless loss of the carrier.

Richards' first tactical assignment was Operation Desert Storm in 1991, flying easy sorties from the *Saratoga* against Iraqi targets. His baptism of fire occurred in that same theatre, when in 1994 the U.S. again occupied Saudi Arabia to destroy Iraq's nuclear strike capability. His first taste of the bitterness of military service was in the European theatre, during Operation Bootstrap, when the U.S. lent support to the Commonwealth of Independent States' suppression of the December Revolt in order to stem the spreading tide of global nationalism. The hypocrisy of the action was apparently not lost on Baseline. Psychological reports at the time pointed to a "lack of

commitment and respect" on Richards' part. His patriotism was called into question. Finally, when no commander would offer him a commission on his carrier, it looked as if his career was over. That's when Commander James Stern, always a maverick, took Baseline under his wing and offered him a place in the fighter group based under his command on the *Shiloh*. The two men formed an undeniable bond in the years that followed, a bond that survived the destruction of the *Shiloh* and the founding of the Wildcats.

GWEN FORRESTER, "PHOENIX"

— ANARCHIST

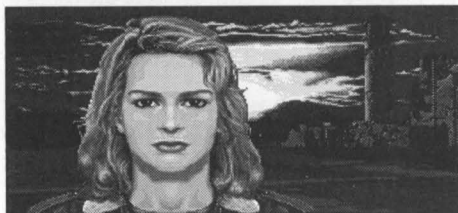

Captain Gwen "Phoenix" Forrester earned her callsign flying evac choppers in Nicaragua. "I was sent in to pull some wounded boys out of the jungle. Talk about anti-aircraft fire, I mean the sky was a solid blanket of smoke from the flak bursts. I couldn't see where I was going, but I went down anyway and linked up with the survivors of the 256th Infantry on schedule. It was easy." She pauses for effect, then grins as she continues: "Taking off again, *that* took guts. You couldn't even see the fraggin' sky through the smoke. But I knew it was there, just the same. And damned if we didn't get out without a scratch. That's when they started calling me Phoenix. Talk about rising from the flames!"

Despite her casual attitude toward the incident, Phoenix was decorated for bravery and promoted to captain as a result of her actions. Ironically, the same fierce independence and rejection of convention that garnered the approval of her superiors eventually led to her "departure" from the service. "I never

really liked the way the brass pushed me around. I've never been much for mindlessly following orders. After a while, that whole damned headset just got to be too much for me. I mean, here were officers that I could fly into the ground giving *me* orders. Who the hell did they think they were? The whole problem is the power principle. Give any idiot power, and it'll corrupt absolutely every time. Pretty soon they expect you to jump through hoops just because they have some braid on their shoulders."

Given this attitude, one might wonder why Capt. Forrester was given an honorable discharge, especially since scuttlebutt has it that the separation was less than amicable. "Did I have something on Uncle Sam?" A silvery laugh bursts forth from Forrester, contrasting nicely with her tough as nails demeanor. "Do I look like the kind of gal who'd do something like that? You'd have to be a pretty nasty customer to be able to pull that one off."

With fiery red hair, steely blue eyes and the unpredictability of a dedicated anarchist, Capt. Forrester seems capable of pulling *anything* off.

JANET PAGE, "VIXEN" — BEAUTIFUL AND DEADLY



Raised around the merchant airfields of Quebec, Janet Page is the only Wildcat pilot without a military service record. She credits the fact that she became a certified jet pilot before the age of eighteen to her icy determination, as well as to her ability to charm the local flyboys into giving her lessons. Due to the attrition among Québécois mercs during the late nineties, mission

openings were easy to come by. Janet used her persuasive powers to secure some of the easier, lower paying missions, gaining experience until, in the space of three years, she had established her reputation as a pilot who would fly any mission, no matter how dangerous. "I wasn't afraid of getting my nose dirty, that's for sure. I figured that was the only way a woman could get their respect, and I was right. I ran guns into China for awhile, punching through the NATO blockade I don't know how many times. That was bouncy. But it paid very well, which is the foremost consideration, right?"

Asked about the name "Vixen," she rolls her eyes and frowns: "My beauty is a tool, and I use it well. Men who want to use me generally wind up getting used. I didn't pick 'Vixen' for myself, but that's what the flyboys in Canada used to call me, and it stuck. I could drop it now, I suppose, but I guess I keep it as a warning. Anyone attracted by my looks should know what they're in for. One tough customer."

Tough is right. Janet is known throughout Istanbul as an uncompromising pilot who will do anything to accomplish a mission objective. "Some call it killer instinct. I just think of it in terms of marketability. Pilots who regularly return from sorties without realizing their primary objectives don't last long. You can't ride on reputation alone in this business. You're really only as good as your last flight. And I've worked too hard, I've come too far, to let anything get between me and my ultimate goal."

And just what is that?

"A girl's got to keep some secrets," she replies seriously, the glint in her eyes flashing a warning not to pursue this question, or perhaps, in anger at this slip in her normally impenetrable armor. Clearly, Janet has her future mapped out with the same precision she uses to gun down opponents. But what that future might be, only time will tell.

BILLY PARKER, "PRIME TIME"

— TOP GUN



First Lt. Billy Parker, or "Prime Time" to the rest of the Wildcats, emerged after four years in the 149th Tactical Fighter Squadron with an unprecedented peacetime total of 36 confirmed kills.

"Hey, what can I say? Put me and a bogie in the air, throw in a couple rounds of ammunition and someone's gonna be history." Clearly, history is a subject Parker has considered intently. "The way I figure it, you're either making history, or you *are* history. A lotta the guys in the Wildcats, unfortunately, are pushing thirty. No doubt which they are." He shakes his head with mock sadness, then breaks into a grin. "But as for me, well, twenty-four is prime time."

To what does he attribute his remarkable success? "Focus and genius. My genius is for aerial combat, but that wouldn't mean zip without a sense of focus. Now, I always knew what I wanted to do, which was be a top fighter pilot. So I joined the USAF as soon as I turned 18. By the time I was twenty I was a second lieutenant in the 149th, and four years later I left with an honorable discharge in my hand and the 149th kill record under my belt. I was free and ready to do what I'd always wanted: clean up kicking burners on the Istanbul market."

Commenting on Stern's reputation as a strong leader with his own iron brand of discipline, Parker admits: "Stern is tough, no question. But his style is different from the military standard. Stern is in charge, yeah, but he still lets you be your own man. You're a member of the team, but the team doesn't absorb you. There's a difference, and that's why I signed on with the Wildcats."

CLAYTON TRAVIS, "TEX"

— RODEO COWBOY

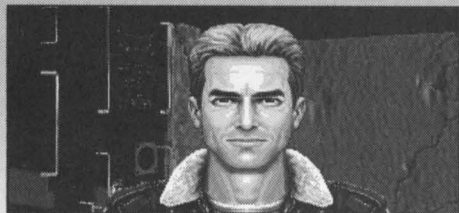

Travis was a senior at Jackson High in Amarillo, Texas, when he joined the USAF.

"I was busting broncs back then," he recalls. "Not professionally, just for fun, but I was pretty good. Anyway, that year the annual Amarillo Rodeo started up, and a lot of low flying jets from the local base were throwin' off booms, and generally spookin' all the animals. So I get pissed, and drive on over to the base, to try to get 'em to cool their jets a spell."

The 29-year-old Travis, who now only answers to the name of "Tex," slaps his knee, laughing. "The recruiter there saw an easy mark, all right. Told me the rodeo wasn't nothin', slapped me into a flight simulator for a spell. I couldn't walk for five minutes after I got out. That's when I knew where I belonged."

At least for a while. Like Parker, Tex opted out of the military after the mandatory four years. "I just couldn't see getting shot at for anyone's reasons but my own. This way, if there's risk I get well paid for it. And besides, I'm not much for taking crap off anyone."

Indeed, Tex projects the classic image of a loner. Tall and lanky, with a cowboy hat usually perched on his head, he looks as if he'd be more at home on the range beside a campfire than in the cockpit of an F-16.

"Yeah, I work best alone, I think. But I don't mind working on a team, so long as I'm calling the shots." A surprising attitude, considering the emphasis Col. Stern puts on teamwork in the Wildcats. On following the orders of James Stern, Tex comments: "One day I'm gonna be running this outfit. But in the meantime, let's just say I'm workin' on it."



Adnan's Place

High munition costs got you down? Need to buy in volume? Look no further! Adnan's Place can fill your bill.

Volume Discounts!

JANUS MISSILES

Bringing our clients the best of the old and the best of the new is what Janus is all about. Every pilot in the militia knows the AIM-9J Sidewinder. Solid, dependable, rear-aspect IR homing air-to-air missiles. Unrivaled in-the-field ruggedness. The absolute best of the old. Now meet the best of the new: The AIM-9M Sidewinder. 100% larger warhead, all aspect capability, 60% more range, and a higher peak speed make the -9M the new standard in IR missiles. Fully compatible with -9J hardpoints! Take a step into the future with Janus!

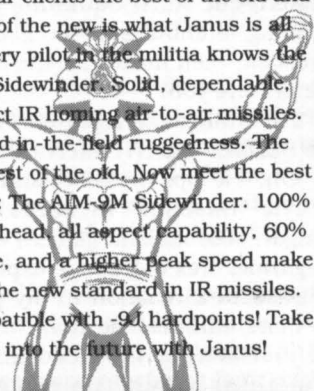

When you need absolute, total, steel-on-target precision, think Paveway! Our full line of laser-guided merchandise is robust enough for the most rugged field conditions,

and inexpensive enough for the tightest client. Free tripod mounted designator with orders of 20 tons and up!

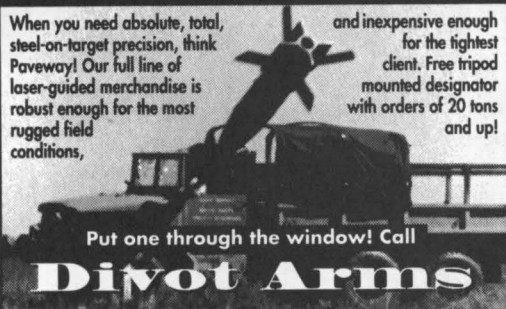

Put one through the window! Call

Divot Arms

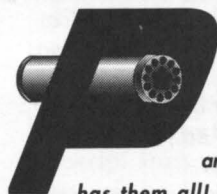

Unguided rockets are the most versatile weapons in any air-to-ground arsenal, and Pendleton has them all! Whether you need flechettes for soft targets or shaped charges for tougher nuts, call Pendleton. Our new improved M261 submunition warhead for the 2.75" model is now available, for those missions when the intel is a little wanting, and you need that AAA gun dead RIGHT NOW! Remember, at Pendleton, if it's in stock, we got it! Free shipping on orders of 10 tons or more.

Pendleton Weapons

ARES ARMS

Ares doesn't just sell tanks. We offer integrated armored fighting vehicle systems to the discriminating buyer. Our T-72/BMP-2 combined arms team is used all over the world. We also cater to the most rigorous air defense requirements. Ares. Call us before your neighbor does.

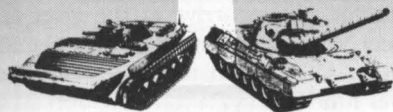

CONCORDE BLASTING MATERIEL



Durandal. Mk. 82. Rockeye. Whether you need to do a little roadwork on the target's runway, or turn a tank column into a junkyard, Concorde has the weapons for you! Unguided munitions still offer the most bang for the buck. Call today!

PYROL ROCKETS

AMRAAM. The state of the art in Air-to-Air! Twice the range and more than twice the warhead of any Sidewinder! And speed, speed, speed! Remember, with AMRAAM, you don't need to spot 'em to splash 'em! Allow 4-6 weeks for orders of 30 or more. Free radar integration with first order.



SELL & SCRAMBLE

A Typical Wildcat Mission • by D. Duhm

[Many thanks to the CEO and Board of MAXIMA for their kind permission to publicize select details regarding this classified operation. As per agreement, certain facts (such as names, dates and other potentially compromising indicia) have been altered; otherwise, every operational detail regarding the mission itself, and all portions involving the Wildcat squadron, their actions, planning and so forth, are accurately represented in order to give the reader a sense of how Wildcat tactical exercises proceed. -Ed.]

Day 1

1000 Hours

After driving through the congested morning traffic of Uskudar, proceeding northeast past the Selimiye Barracks, I finally reach the narrow dirt road that leads to the Wildcat Base, which some of the Wildcats refer to affectionately as the "Lair." My jeep is greeted by a single yapping malamute. The base appears deserted, until the dog's barking draws an armed sentry from one of the rather dilapidated buildings that make up the base. He regards me with suspicion, Uzi lowered but ready in his right hand.

"I'm Duhm, with *SUDDEN DEATH*." I offer him my press card. He studies it carefully, then waves me on.

"You can park your jeep over there."

"Where is everyone?"

"Asleep." He looks vaguely annoyed at the question. "Help yourself to coffee in the hangar. They'll be up sooner or later."

1233 Hours

A man whom I recognize from my background reading as Clayton "Tex" Travis staggers into the hangar, dressed

in torn jeans and an unbuttoned, western-cut shirt. Squinting against the blinding Istanbul sun, he glances in my direction, then makes for the coffee. "Who the hell are you?"

"I'm Duhm, the reporter. I've come for the *SUDDEN DEATH* interview."

"Oh." He sips the coffee and winces.

Lyle "Baseline" Richards enters the hangar, sees me and glances at Tex. "The magazine," Tex mutters in explanation.

Baseline's reaction to my presence is no more enthusiastic than his partner's. He just shakes his head and mutters something about "no fragging peace around here." Within the next thirty minutes most of the Wildcat pilots have stopped by the coffee pot and ignored me, until finally at 1327 a short, balding man, dressed in suit and tie despite the midday heat, sweeps into the hangar and pumps my arm profusely.

"Sorry, oh so sorry to keep you waiting. I thought I'd made myself clear regarding the time." I realize it is Virgil Beetlebaum, the Wildcat accountant. He has been instrumental in setting up this article, although I've paid for the service many times over, in phone bills and ear-leather.

"You said the start of the business day, didn't you?"

He nods emphatically. "Yes, but I meant for you to arrive at the start of a Wildcat workday." I stare at him blankly. "I am so sorry about this. Let me fill you in over lunch, okay?"

He leads me by the arm out of the hangar. I hear the rest of the squadron behind me chuckle in apparent sympathy, for what reason I'm not sure. But as I listen to Virgil yammer on, I begin to get a pretty good idea.

"When we're between jobs, as we are

now, the Wildcat workday doesn't really begin till about 2000, when Selim's opens. That's where we go to dig up work. And toss back a few." He laughs a little too heartily, implying that even accountants can get down and dirty with the boys. I smile weakly, feeling queasy from the six quarts of coffee I drank while waiting around in the hangar.

Well, it sure felt like six. When measuring time by coffee, the minutes can seem like ounces.

He takes me into his office, excuses himself profusely as he exits, and returns panting with a loaf of bread, some mustard and bologna. He fixes me a sandwich as he rattles on and on. I notice he cuts the crust from my bread. I say nothing.

"I can tell we're going to get on splendidly." Virgil straightens his tie, displaying his caps in a rictus that I suppose, over more appetizing fare, might pass as a smile. "I certainly hope you're going to give us a — favorable write-up." He winks and laughs.

I force the bologna-mustard paste down my throat, and try to smile.

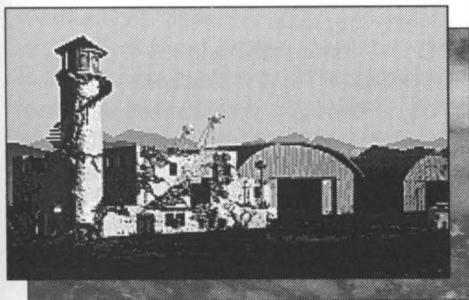

The Wildcats' home base, nicknamed "the Lair"

1510 Hours

I manage to escape Virgil, under pretense of relieving my bladder. I slip out the bathroom window and prowl the grounds looking for some of the other Wildcats. Again, all the senior pilots seem to have disappeared. I have the feeling they're hiding from me, so to kill time, I give myself a tour of the base. the Lair is

an eclectic conglomeration of high tech dinginess, crumbling cement structures supporting sophisticated radar systems, top-flight F-16s sheltered by a rusted hangar. And its history is equally curious.



The Wildcats assembled

The base functioned during WWII as a private airstrip leased to the government, and the 53rd Screaming Scorpions flew many successful campaigns from its airstrip. During the fifties it was abandoned when it ceased to be profitable, and allowed to deteriorate. It next fell into the hands of Luis Simone, the infamous cocaine dealer, who used it as an intermediate touch point in his international smuggling network. The government busted the ring in '94, and seized the base along with the rest of Simone's contraband. It fell into disuse again until 2004, when James Stern signed a long term contract to purchase the property as a base of operations for his burgeoning squadron, Stern's Wildcats.

Stern and Jean-Paul Prideaux jointly initiated the high-tech retrofitting that now characterizes the Lair as a professional base of operation. But staring now at the base, standing stalwart if damaged against the afternoon heat, at the peeling plaster revealing the bricks of mud and straw beneath, the occasional bullet holes dug into stone (some framed by dark red stains), I hear these buildings softly whispering to me of pirates and past glories. Since no one else is talking to me at the moment, I am content to pause and linger respectfully over the reminiscences of an old, old soldier.

1615 Hours

At last, someone gives me the time of day.

"1615," says Miguel Schraeder, as he walks away.

Encouraged by even this faint acknowledgement, I follow him to the hangar, where he proceeds to direct a crew of mechanics in the maintenance of the F-16 fleet. I am surprised to find that "Zorro" Schraeder, a veteran of the Central American Bloc Conflict, is the Wildcat's senior mechanic. Generally, crack pilots consider the mechanics of craft maintenance and repair beneath them. I mention this to Schraeder and he frowns.

"That is an elitist attitude. A mechanic serves as important a function as a flyboy. One is more glamorous, perhaps, but if you fly for glamour's sake, you're in the wrong business." He points to his ground crew. "If not for them, we'd never leave the ground."

Schraeder, initially distant and preoccupied, grows more animated as he warms to his favorite subject. "I liken it philosophically to the problems in Latin America. Every country seeks to be elevated from the Third World (an obsolete term by the way, considering the collapse of the U.S. economy), but these Latin American governments still aspire to that lost U.S. ideal. They want the glory, but are unwilling to lay the groundwork, a solid foundation of opportunity for the impoverished, hope for the common man. No, the generalissimos prefer to gain their wealth through conflict with their neighbors, who are in the same boat. This creates a constant state of flux throughout the region. You gain, you lose, and no political/economic structure endures."

My knowledge of Latin American politics is too limited. I try to change the subject. "Tell me a little bit about James Stern. When will I get a chance to see him?"

"When Stern appears," Schraeder says sullenly. Clearly, I've lost his interest.

The man called Zorro dismisses me bluntly, turning his back on me and

directing his attention once again to the repair of his precious aircraft.



Miguel Schraeder and one of his charges.

1722 Hours

I spy Billy "Prime Time" Parker and Gwen "Phoenix" Forrester approaching me from across the Lair's central airstrip. Since I missed them earlier at the hangar, I am especially eager to interview them, and hurry toward them. As I approach, Billy holds out his hands expectantly, looking annoyed. I hesitate, then shake his right hand. He sighs.

"Yeah, yeah. Come on, dude, I haven't got all day."

"What?"

"Hurry up, man."

"Uh — listen, my name's Duhm, I'm from *SUDDEN DEATH* magazine —"

"Oh. I thought you wanted an autograph." Forrester bursts into laughter. Parker frowns. "Well, that's what they usually want," he grumbles. He goes on to explain that he is a local celebrity, and frequently gets such requests from fans of his occasional appearances in air shows, which most other mercs avoid. The last thing your average merc wants is notoriety. Billy is different.

"Hey, if you've got it —" He winks at Gwen, who shakes her head and walks away, scowling. Prime Time watches her a moment, frowns and then hurries away, promising to speak to me later in Selim's.

Yeah, I find myself thinking as I eat his dust, *and the check is in the mail.*

1902 Hours

The hollow crack of gunplay fractures the deep evening stillness. I leave my crustless bologna and mustard sandwich (provided by you-know-who) in the hanger and brush past some bored-looking junior pilots to see what the commotion is about. The sky is dark now, except for a last strip of red hugging the horizon. I stumble over the uneven ground, following the intermittent sound, until I discover Tex standing by the flight tower/control complex, a .45 calibre Taurus in his hands and a grin on his face. I ask what he's doing. He explains.

"Well, see, I like to hunt. Now, there ain't no proper game to speak of in Istanbul. But we sure do get a lot of rats." He points them out to me, little shapes skittering across the roof, silhouetted against the sky as the sun goes down. "They pretty much hide during the day, but come dusk, man they're all over the place. Big ugly sombitches. They come over from Uskudar. Filthy place, I mean, someone needs to tell those folks it's the twenty-first century, and that means you don't dump your shit in the streets. Do rats eat shit?" I shrug. "They must. I mean, look at all of them." He pulls off another shot, misses.

"Virgil ordered poison, but that don't do diddly," he continues. "The straight-on approach is always best. I don't like to mince around, like some people around here."

I ask him what he means by that.

"I mean, anyone who gets into the merc business and then turns down jobs because they're dirty is a trifle confused, if you get my meaning."

"Then why do you stay?"

Tex rubs the back of his neck meditatively a moment. "I respect Stern. Don't get me wrong. I think he's got some screwy ideas, but he's also one of the finest men I've ever known. I reckon one day he'll retire, though, and then we're gonna see some changes."

"What kind of changes?"

"Listen, it's only a matter of time before I wind up in command of the Wildcats. It

won't take me long after that to convince everyone it's time to start making some serious money."

"You think the Wildcat commitment to moral operations will disintegrate after Stern's gone?"

He nods. "And I'll be there to pick up the pieces." Tex looks down at his pistol. "Y'know, once I was shootin' around the hangar and I put a hole through one of the fuel tanks. Everyone hit the roof, Stern was mad as hell, and he ordered me not to shoot rats again."

"He forbade it?"

Tex nods, and pulls off another shot. A crooked grin spreads across his face. "Got him. Did'ja hear him squeak?"

I shake my head. "Not over the gunfire."

Tex shrugs.

"Kind of a acquired talent, I reckon."

2040 Hours

Our convoy of jeeps reaches Selim's. I still haven't seen Stern (he evidently drove on ahead alone), but the rest say I'm certain to catch up with him in the cafe. Sure enough, as the Wildcats linger in the bar or merge into shadowy corners that breed questionable exchanges, I catch my first glimpse of Stern. He is seated at a table, bargaining with an uptight executive-type, who keeps glancing nervously about, as if afraid of being caught in some disgusting act. Lyle Richards is seated at a table alone, several rows behind Stern. From his watchful, tense posture, I get the feeling he's covering Stern, though no weapon is

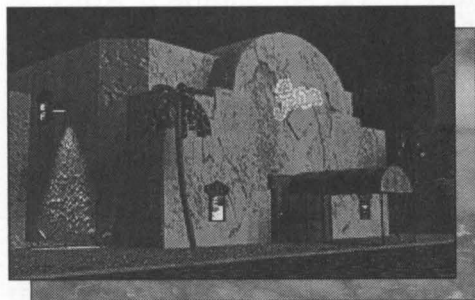

A familiar nightspot, Selim's

in sight. Richards, even more so than his tight-lipped teammates, has been reluctant to reveal any personal information about himself. I decide to sit with him, and attempt to penetrate the man's silence. Since he brushes off personal inquiries, I ask him instead about Stern.

"I understand that your commander has had a very difficult career." Lyle grunts noncommittally, scanning the crowd. "For instance, the loss of the *Shiloh*. That must have been a difficult blow after such a distinguished career."

Lyle looks at me sharply. "What do you know about it?"

"What everyone knows," I answer, I must confess, a bit uneasily. His direct gaze is oddly unsettling. "During the PetroWar of 2001, Stern launched an aerial attack from the *Shiloh* just off the coast of Alaska. The carrier was to serve point in a two-front aerial and amphibious assault against the Alaskan secessionist army. When the *Shiloh* went down with all hands, it essentially doomed any chance the U.S. had of keeping Alaska in the Union. That disaster ended Stern's Navy career."

"Wrong," Richards says quietly. "Stern ended Stern's career. He retired from the Navy. Maybe you ought to do a little more research."

"Sure, he resigned, but what choice did he have? He lost a nuclear carrier in a crucial tactical operation, and the U.S. war effort collapsed because of it."

Richards spins on me, taking his eyes off Stern for the first time since I sat down. "Get this straight: Stern warned those fools in Washington that the operation was doomed from the start. There were four other carriers at the strike point, Canadians, Russians, OPEC — they all wanted a piece of the action, bargaining with Alaska for drilling rights in exchange for protection. Those Pentagon idiots missed their opportunity six months earlier, before the Alaskans wised up and requested outside intervention. By May it was just too damn late. Alaska was gone."



Janet Page and "Tex" Travis off-duty at Selim's

Richards glances back at Stern. "Besides, some Americans don't like killing other Americans just because they want to be free. The *Shiloh* turned Alaska into a flaming hell before she finally went down —"

"With only two survivors."

"Yes." Richards looks down. "Only two."

We hear a violent crash from Stern's direction. Richards is immediately standing, the pistol in his hand seeming to materialize from thin air. He aims, every muscle tense. High-pitched screaming echoes off the hard walls. I turn in my chair to see what has happened.

A waiter is on the floor, hands over his head, crouched in a puddle of water beside a broken pitcher, yelling frantically.

"Please, don't shoot! Accident, don't shoot! don't shoot —"

From various strategic points in the cafe, ten armed men gradually relax, lowering their guns. Stern gives Richards a nod. Richards takes his seat, slowly replacing his pistol in his leather jacket.

Noting the look on my face, Richards grins. "That's why everyone orders finger food. You don't want to drop a fork in here."

"I can see that."

"Clumsy moron," he says, the smile fading. "He gets no tip."

Richards lapses into stony silence, ignoring any of my further attempts at conversation.

2237 Hours

The evening's business is concluded, and excitement fills the air. Stern has closed a deal, apparently quite a lucrative deal. Although the details are not yet available, everyone can breathe easier now, at least until morning; the pressure to sell themselves over, tomorrow they'll turn their attention to staying alive. But for tonight, everyone stays behind drinking as Stern heads out the door, his stony exterior cracking long enough for him to give his team a wink and a thumbs up. No late drinking for him, I'm disappointed to discover. I'd hoped that he would loosen up after a few belts, but Stern takes his responsibilities too seriously to indulge himself. Along with Richards, Stern drives back to the Lair, leaving his pilots behind to blow off some steam.

The bill collector will be held at bay yet another month, and in the uncertain life of a merc, this is cause enough for celebration. Most squadrons teeter on the brink of perpetual bankruptcy, but far from being just a job, the Istanbul scene is a way of life that hardened mercs are helpless to surrender. Another day, another bullet, another funeral, another dollar. An addiction both destructive and legal, an irresistible combination. I see it in the way Richards drew his gun in the cafe, the way Schraeder lovingly supervised the care and feeding of his deadly pets in the hangar. You never feel so alive as just after you've looked death in the eye.

Gwen and Billy renege on their promise to talk to me "later," and head off for a dark corner. I'm surprised to see Janet "Vixen" Page with one of the Wildcat pilots at a secluded table, engaged in what appears to be intimate conversation, and Schraeder is talking to Virgil at the bar. Not wanting to get sucked into that particular conversation, I leave Selim's and take a taxi back to the Lair. From what I understand, tomorrow will be quite different from today's lazy pace.

Day 2

0500 Hours

Damned early. Damned, damned early. Still dark out. Tex looks at the rats on the roof of the hangar forlornly, but even he doesn't dare break the morning silence, not with all his comrades milling around inside the hangar. He gives the rats a look that promises deferred pain, then steps inside to join his peers.

A long table supports the Wildcat version of a breakfast buffet: coffee, aspirin, antacid, bologna, mustard, bread with the crust trimmed off... The Wildcats pace anxiously as they wait for Stern's briefing, some clutching their heads and complaining bitterly about hangovers as if such things were curses leveled by God against them for utterly inexplicable and vindictive reasons. There's lots of nervous chatter, jovial insults flying back and forth, pilots quipping about the cuisine at Chez Virgil, Virgil bitching in turn about the food budget —

And then Stern arrives. The room grows silent. Stern speaks quietly, but his voice carries throughout the hangar as he begins.

"We're going to repo a Maxima Gold Card."

Commotion. Gwen hoots and claps. Billy and Tex exchange high fives. Richards appears anxious, Janet greedy, Miguel startled — the reactions vary, but no one is unaffected by the announcement.

A Maxima Gold Card. The most coveted object in all the world. Available to only the megawealthy, the most obscenely, decadently affluent citizens of the earth, it provides the bearer with unlimited credit, and is what Maxima Corp terms an "electronically secure credit line" — in other words, no one, not even Maxima Corp, can imprint, update, download or otherwise tamper with a Maxima Gold Card. Charges are noted by computers at point of purchase, but the Maxima Gold Card is an old-fashioned "read-only" card, keyed to the user's thumbprint. This feature provides the ultimate fiscal security in an era of hackers and electronic theft. But it is the

final feature of the Maxima Gold Card that concerns the Wildcats now.

The Maxima Gold Card cannot be electronically revoked. Any Gold Card that Maxima Corp wishes to deactivate must be repossessed in person by a duly authorized member of the Maxima Board of Directors, and then physically destroyed. It is considered "a privilege of membership."

"Maxima Corp wishes to repossess the Maxima Gold Card belonging to one Claude Guillaume. It seems that Mr. Guillaume dropped in excess of a billion dollars on the market last week, which knocks him out of the Fortune 10, placing him somewhere down in the Fortune 20s and making him ineligible for continued membership.

"Now, Mr. Guillaume owns an island in the Aegean. It is heavily defended, as you'll see, and that's where we come in.

"Mr. Petrie, of Maxima's Board of Directors, has hired us to fly him onto Guillaume's island, and then escort him into Guillaume's presence, where he will personally repo the card."

Stern proceeds to discuss the tactical situation, specifically Guillaume's defenses. Detection of hostiles at 100 miles. Patrol boats with anti-aircraft measures. A fleet of *Tomeats*. AMRAAM long-range missiles, AA batteries dotting the island, a small but highly skilled security detachment on the grounds of Guillaume's mansion. Stern informs us that the Wildcats will be coordinating with an assault team who will be making an amphibious landing on the southern tip of the island. It will be the assault team's job to eliminate or severely curtail the security threat on the ground, enabling the Wildcats to land. They will need air cover in turn for their own landing.

"This will be a Grade One assault, people. Our object is to locate Guillaume and escort Mr. Petrie to him. There should be no civilians in the waters or on the grounds, so all necessary force is approved."

0700 Hours

Schraeder is busy conferring with his teammates about the ordnance they will carry and any peculiarities in the planes they'll be flying. He knows each craft inside out, its weaknesses, strengths and eccentricities, which creaks are not a problem and which spell trouble. Each jet has been repaired any number of times, and the pilots know it. They argue among themselves, jockeying for the best planes, despite Miguel's annoyed assurances that every one is battle worthy.

Meanwhile, Stern is discussing budgetary considerations with Virgil. Virgil briefs Stern on how many fighters can be sacrificed as "acceptable losses" ("None," Virgil states sharply) and how much they can afford to spend on ordnance. Virgil is especially relieved that no strike base will be needed on this mission. Often, the Wildcats must set up makeshift bases for overseas assignments, transporting what they need in gigantic C-130 *Hercules* transports. The expense of setting up such a base is considerable, and eats into the profits despite contractual allowances designed to cover it. Fortunately, Guillaume's island is located in the Aegean, which means they can operate out of the Lair, much to Virgil's relief. Page jokes that perhaps now they'll be able to afford bread with crust. Virgil suggests an activity that Page can indulge in alone, and in her spare time.

0723 Hours

I finally get a few words out of Gwen.

"I can't wait to repo this bastard's card," she says, pacing the Ready Room nervously. "He probably thinks he's got everything under control, master of his own fate and all. Money does that to people. They don't understand about freedom coming from inside, think they can just buy it, buy anything. Fat cat capitalist bastard."

I notice that Gwen sports the anarchist's symbol on her helmet as Miguel walks into the room.

"I agree. The Maxima Card is immoral. You could feed all of Latin America with one of those rich man's toys."

All the pilots are placed on final standby. Launch is at 0800.

0754 Hours

All the Wildcats are lined up beside their planes when Mr. Petrie is escorted onto the strip. He glances around nervously, flashing strained smiles in all directions, turning his helmet over and over in his hands, looking like a man on the way to the dentist, although certainly this particular extraction will be much more painful. He is shaking so badly as he climbs into the *Falcon* trainer (a two-seater), several Wildcats stand beneath him ready to catch him if he slips. Schraeder buckles him in, then climbs into the front cockpit. Petrie's sweating face is engulfed by the helmet as he slips it on. I imagine he's grateful to have the helmet hide his anxiety from the world. I know I am.

I'm sitting in a second trainer, going up with "Prime Time" Parker. They permit me to tag along as an observer because I've had experience in offensive ground ops, and also because *SUDDEN DEATH* paid dearly for the privilege. I'm damn scared. I'm not a pilot, and I've never flown in a jet before.

"Gonna be a bumpy ride," says Prime Time, smiling cheerfully as he climbs into the cockpit in front of me. "But I'll try not to pull more than six Gs."

"I appreciate that." I'm going to black out. I'm going to throw up in my mask and drown in my own vomit. I know it. Prime Time knows it. That's why he's so damn cheerful, the sadistic bastard. Of course, assuming I hold on to consciousness, I'll be expected to hold my own against Guillaume's ground troops once we land. And then there's the flight out.

Yes indeed. It's beginning to look like one of those days.

0930 Hours

It's been a smooth ride until now. Parker, following his wingleader's example, descends until it seems we're just barely skimming the waves of the Aegean. In this way, the Wildcats hope to avoid Guillaume's radar as long as possible.

0943 Hours

About 75 miles out from the island, we encounter the first wave of enemy resistance. Prime Time initiates a rapid climb, the tone that warns of a positive missile lock piercing the white noise of the cockpit. I can't even see the damned thing that's trying to kill me. I'd feel better if I could. At least, I think so.

0946 Hours

I see it coming. I don't feel any better. The chatter over the radio is calm. I am anything but. The thing is radar-guided. Prime Time waits until the proper moment, releases chaff and veers off, hitting the afterburners. I see the missile explode harmlessly behind us —

1010 Hours

Dogfighting, close and personal. Long-range missiles are too expensive for most private squadrons, so the majority of dogfights on the mercenary level consist of guns, Sidewinders and other short-range missiles. The battle around me seems abstract, a jockeying for position; the soothing, even drone of white noise punctuated now and then by a message, or a control tone, or the faint rattle of gunfire. Every once in a while, an enemy



War at sea "Wildcat style"

jet, leaving a smoking trail, crashes into the sea without further ado. Parachutes punctuate the sky randomly, final exclamation points marking the end of another phrase in the drama staged around me. At any moment, I expect the cockpit to tear away, to feel the incredible thrust of the ejector jets in the seat beneath me as a missile slams into the engine behind me. I can't believe I've gotten this far, with so much random destruction flaring around me.

1030 Hours

The island is in sight. Beneath us, patrol boats are engaging the amphibious landing craft of the assault team. Our wing breaks off and begins strafing the boats, clearing a corridor for the craft to land. Other wings keep the F-14 *Tomcats* off our backs as we sink the defending gunboats. Likewise, they draw off the AA fire from the island proper, giving us time to do our job. I'm more amazed at the seamless harmony now than I am afraid. This is coordinated, deadly beauty.

1040 Hours

The assault team has made its landing. As the other wings continue dogfighting, our wing moves to disable the AA batteries along the southern beach. This accomplished, we strike against enemy ground positions, allowing the assault team to proceed toward the mansion.

1100 Hours

The airfield is secured by the assault team. Phoenix and Gill-Man initiate landing. They assess the tactical situation, and clear us to land. We head in and touch down smoothly.

Members of the assault team initiate refueling of our jets as we hit the ground running, helping themselves to Guillaume's ample supply of fuel.

We proceed along a secured corridor toward the mansion. We pass immaculately kept grounds, swaying palm trees, fountains and statues, keeping to a marble path that leads to the front steps.

Snipers open up on us from upstairs

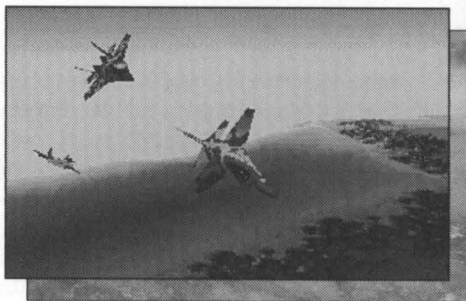

The Wildcats go "feet dry"

windows. We dive for cover, and return fire. At last I'm able to contribute something to this operation. With little trouble, I eliminate one of the snipers. The other retreats.

We proceed. Petrie doesn't look at all well. I wonder how I look.

A division of the assault team enters the mansion ahead of us. More gunfire. Screams of agony. The aerial part of the operation seemed largely abstract, explosive and spectacular. Now, there are only the same, sorry sounds of men dying, in fear, in pain. Same sorry adrenalin rush, the same stench in your nostrils, of smoke, of death. We get the all clear. We go inside.

1113 Hours

We locate Guillaume.

In a robe and slippers, he lounges in his posh, Victorian-style study, nursing a cup of coffee and perusing a *Wall Street Journal*. He looks up at us in mild annoyance, grubby aliens in his elegant world, mismatched shades in an otherwise impeccably coordinated color scheme.

"Do wipe your feet before you come in." He gestures to the rug. "Two million dollars."

"Two million?" Forrester deliberately puts her muddy feet on the antique Persian rug. "So what's a fifty dollar cleaning bill, more or less?"

Petrie frowns at Forrester and wipes his feet before entering the room. Guillaume folds his paper and rises, offering his hand to Petrie.

"Hello, Anton. How nice to see you."

Petrie smiles. "Claude. How are you?"

"Fine, just fine. I've taken up tennis, did you know?"

"Oh really, we'll have to play sometime."

"Yes, yes, we really must. So. What brings you all the way here, Anton?"

Petrie sighs, looking embarrassed.

"This little matter of the billion dollars —"

"Ahhhh —"

"I hate to even mention it. You know I'd cut you some slack, but the rest of the board, well —"

"Quite. Quite. The vicissitudes of the market —"

"So true."

"Win some, and so on. Well. I guess you'll be wanting that Maxima Gold Card back?"

"If it's not too much trouble."

"Not at all." Guillaume opens a desk drawer and produces the credit card. "Here you are."

"Have time for coffee?"

"Only just."

1125 Hours

While Petrie and Guillaume share coffee and cake in his study, Forrester stands at the top of the stairs, fuming. Parker reaches out, trying to calm her down. She slaps his hand away.

"Don't tell me to chill, damn it! Look at this!" She jerks an angry thumb at the bodies littering the stairs, the blood smeared on the walls, the craters and destruction in the bay window beyond. "People died here, and for what? Lives sacrificed at the pleasure of the rich."

Parker tries to reason with her. "That's what we're paid for. Every time. Where there's money, that's where we go —"

"Obscene," she mutters, staring back at the closed door of the study. "He doesn't even feel it. God, I wish I could make him *feel* it."

1200 Hours

Petrie and Guillaume stroll down the stairs ahead of us, chatting amiably, Guillaume pointing out his various

treasures. At the foot of the stairs, Guillaume pauses to point out an ancient vase on a pedestal, specially lighted, encased in glass.

"Circa 816 B.C. China." His eyes gleam proudly as the vase rotates in its special atmospheric envelope. "Priceless."

"Incredible," Petrie whispers.

They move towards the door. We are proceeding down the stairs, when Forrester trips. Right beside the vase.

Somehow, her elbow punches through the glass and into the vase.

"No!" Guillaume screams in sheer horror. But it is too late. Forrester pulls her bleeding elbow out of the case, leaving vase and glass fragments mingled within.

"Oops," she says.

"You — *you* —" Guillaume's face is purple with rage as he attempts to spit out the word: " — *bitch!*"

"Sorry about that. How clumsy of me."

"Do you realize how much that was *worth?*"

"Thought you just said it was *worthless.*"

"Priceless!"

"Whatever."

Holding her elbow, Phoenix steps out the front door. We follow her.

We can hear Guillaume cursing all the way down to the airstrip.

1600 Hours

Back at the Lair in Istanbul. Guillaume evidently decided to cut his losses. We encountered no resistance on the way out. Petrie has written the Wildcats a check for payment in full. No craft or pilots were lost. It's been a good mission.

Gwen still maintains the vase was an accident.

Everyone retires to the barracks for a nap before the night's action. Back to Selim's, looking for another mission. Sell and scramble, an endless cycle.

Silence again settles over the base as I start the drive back to the *SUDDEN DEATH* offices in Stamboul.

The lone malamute barks his farewell.

I round a bend, and the base vanishes in my dust.

CONTRACT:

TERMINATED!

AN ENFORCER SPEAKS OUT

by "Gule Gule"

[After untold centuries as an exclamation of fond farewell, "Gule, gule," or "go cheerfully," was transformed in just five short years into a phrase whispered with dread, from the darkest corners of the Stamboul quarter to the gaudy, blood-stained sidewalks of Istiklal Caddesi in Beyoglu. It seems fantastic that a lone assassin, whose name to this day remains unknown, had only to embrace the innocuous phrase as his *nom d'plume* in order to stain it forever. I arrived in Istanbul after the disappearance of Gule Gule in 2009, and so decided that the tales regarding his exploits (some might call them atrocities) were wild exaggerations, mercenary myths designed to keep potential defaulters in line.

However, all my doubts were dispelled when I received a phone call at the SUDDEN DEATH editorial office late one August night instructing me to cross over to Uskudar for the story of my life.

We met at a deserted warehouse near the Legionnaire Hotel, across the Bosphorus in Uskudar. He stood, and with a courteous, soft-spoken voice that belied his powerful frame, invited me to take the seat across the table from him. He wore a simple black British Commando sweater, reinforced at the shoulder and elbow by rugged twill patches, black cargo pocket trousers, a pair of knobelbecher boots and a pair of kid gloves that, even from a distance, I recognized as powdered lead sap gloves, gentle to the fist and deadly to the skull. As I took my place, I could see no hint of the 9mm Heckler & Koch P7M13 pistol I knew from reputation was concealed on his person. Nor did I look for the Gurkha Kukri knife sheathed in his left boot. I knew from the stories that you never saw it unsheathed unless it was about to be used. I

knew from the stories you never wanted to see it, period. Far better the pistol than the knife, hence the dreaded name, an exhortation to "go cheerfully" — Gule Gule detested cowardice. So long as none was displayed, an easy dispatch with pistol was promised. But God help the coward, begging for his life, who saw that warped Nepalese blade sliding out oh so slowly from its sheath, whispering of the prolonged pain to come.

Once seated across the table from me, Gule Gule introduced himself, and briskly got down to business. He was disturbed by some recent trends he'd seen in the Istanbul market. Since his disappearance four years ago, employers have lapsed into old habits, in particular defaulting on payments to mercs. Concerned that the money interests have forgotten the name of Gule Gule, and feeling something of an obligation to the mercs of Istanbul "who consider me something of a folk hero," Gule Gule wished his story to be told.

"I want it known that I am not dead," he said with a smile hinting at a weary sadness. "Retirement, success, these things have been mistaken for defeat. Only in Istanbul," he laughed softly. Then his face grew serious again. "I want the thieves who think they can cheat mercs to realize that retirement can be reversed."

What follows, then, is the story of Gule Gule in his own words, as was told to me that August night. I sincerely believe Gule Gule when he says that he may yet come out of retirement if the situation does not improve. As the most infamous enforcer in Istanbul history, Gule Gule would doubtless prove the worst nightmare of any business interests who have defaulted on blood money.]

I have an anecdote for you. Two actually. But one is shorter, and will do for a beginning.

I had tracked M. Chevrier and his personal guard to the Galata Tower in the Beyoglu section of Istanbul, not a good place to be during the day if you weren't hard, or after sundown even if you were. By the time the lights flared to life in the exclusive tower nightclub, dusk had lured the first resentful shadows from the doorways around me. The users and the used both scrutinized me with their customary interest, but only briefly.

I was not unknown to them.

They gave way with downcast eyes as I entered Galata Tower.

I took the lift to the top floor and walked up to the maitre d', a smile on my face, my right arm concealed in the folds of my greatcoat. He was an oily man in evening wear, perched behind his station at the entrance to Club Mozambique, his pencil thin moustache twitching as his eyes raked over my admittedly grubby coat.

"We have a dress code here, *sir*," he said. Then his eyes met my own.

He paled.

Covertly he pressed a button beneath the lip of his station. The curtain behind him parted, and a large Turk with an M16 gestured for me to leave. Clearly, he expected me to comply without fuss. He looked surprised when I yanked the VZ 61 from my coat, until its silenced blast forever banished any expression from his face.

"My disappearance four years ago seems to have inspired a return to the corporate credo of old, of employers who view mercenaries as cannon fodder, expendable and cheap..."

"I do not enjoy being thought of as a monster. I kill, yes. But never innocents."

The Turk was a hired killer, of course, and death to him was an occupational hazard. The maitre d', on the other hand, was a civilian, so I took the extra time to knock him unconscious. That kindness almost cost me dearly — he managed to scream before dropping to the floor.

The Skorpion had a silencer, and I might've gotten into Club Mozambique without fuss if I'd simply killed him. As it happened, one of M. Chevrier's bodyguards within the club glanced up, alerted by the waiter's girlish squeal of alarm, and saw me.

I dived for the floor as the bodyguard reached inside his jacket. I felt the first bullet shatter against the floor beside my left temple as I pressed the Skorpion's light wire butt against my shoulder. I felt surprise at this bodyguard's quick reaction. He was unexpectedly good. I allowed him to squeeze off one final shot as I centered my sights on his forehead. His round kicked high, smashing the pot of a rubber tree behind me.

I could not permit him another.

The other bodyguards, slow to react, were only just turning around as their friend's head blossomed red in the garish cabaret light. I felt a moment of pity for M. Chevrier.

Good help was so hard to find.

I dispatched the remaining bodyguards without further ado, the sluggish ones, hands still inside their now rather hopelessly stained white dinner jackets, as they discovered too late that their guidance counselors had steered them into a very deadly profession.

"I offer this tale from my past as an example. And a warning."

I picked up the Turk's M16 and walked over to M. Chevrier's table. His back was to me. He peered slowly over his shoulder, eyes wide, a strand of spaghetti dangling from his pursed lips.

"M. Chevrier?"

The strand vanished with a slurping noise. "Why, no. You've mistaken me for someone else."

I laughed. He laughed, dabbing at some sauce at the corner of his mouth.

"M. Chevrier, we have inconvenienced these good people enough for one night. Would you please step outside with me?"

"Of course, of course," he said, waving his hand in placation as he stood up, still chuckling.

We strolled together from the restaurant, and M. Chevrier held the door for me as we emerged from Galata Tower. I led him to an alley, cleared it of riff-raff with a few warning shots, then lit a cigarette for M. Chevrier. He accepted it with eyebrows raised in pleasant surprise.

"A Camel. My favorite brand."

"My research is always thorough."

He nodded. "I'd expect nothing less of Gule Gule." He took a long drag. "I will triple your pay."

I shook my head. "Unlike you, Monsieur, I never go back on a contract, no matter the profit margin. You understand, surely?"

"Of course, of course." He looked sad as his last Camel turned to ashes. "I had to try."

Somewhere in the streets, someone started screaming. He swallowed. The first indication of fear I'd seen from him. "I hope you're not going to beg," I said.

"No," he replied, smiling. "I know better. And what the hell. I've had a rich life."

I smiled back. "Another Camel?"

As he reached for the pack, I blew his brains out.

The kindest killing is the one with the least ado.

"I will not go into much detail regarding my background, for the obvious reason that I wish my true identity to remain unknown even today."

I tell you this story for several reasons. Firstly, I do not enjoy being thought of as a monster. I kill, yes. But never innocents. M. Chevrier had reneged on a

contract to Templer's Tigers, a flying squadron who flew an honest mission for the man, sustained blood losses and then were cheated out of their rightful pay. He knew the risk of such a default. It was perhaps unfortunate for him that I was put on his case. But that was always a possibility. And notice, though it would've been convenient

to eliminate him, I went out of my way not to kill the hysterical maitre d', even though he was a coward, and threatened my operation and personal safety margin. I am not a monster, but a merc only, and a damned good one.

Another reason I relate this tale to you is to com-

memorate the bravery of M. Chevrier. Up to the last, he was courteous, pleasant even, and rouge or not, I will always give a brave man a fair deal. If only all my targets could go so cheerfully. Which leads me to my second, more important anecdote.

But I'm sure you first want the explanation of why I stepped out of retirement to bring you these stories. My disappearance four years ago seems to have inspired a return to the corporate credo of old, of employers who view mercenaries as cannon fodder, expendable and cheap, and undeserving of honorable treatment. To those monied interests who feel tempted to default on payments for blood, I offer this tale from my past as an example. And a warning.

It was late November of 2004, during the first heady days of mercenaries, only a few months after Turkey extended "Diplomatic Forces Immunity" to any mercs who chose to operate from within her borders. I was one of the many faceless hopefuls who had flocked to the

"Though I was more qualified by training to kill than some of those around me with greater experience, I was unproven to the powers that channeled in human lives in Stamboul."

promise of the new Istanbul, one of a thousand stalkers prowling her streets in search of the few jobs available at the time. Merc employment was difficult to come by, since the market structure was only beginning to form, and those corporations who had engaged murderers privately were still leery of pursuing their bloody vendettas in the light of government sanctioned respectability.

Still, the promise was enough for us, professional killers offered a haven for our dark craft. Some of us were veterans of dozens of wars in every imaginable theatre, obviously dangerous in the natural, off-hand way that a savage animal, even slumbering, prompts you to pass it quietly and with downcast eyes. Others such as I, young and comparatively inexperienced, muddled through that back alley world with jaws self-consciously squared and eyes glazed with a layer of icy hardness that was often thinner than anyone might suspect.

**"So I hung around the bars,
following leads, bidding my time,
awaiting only an opportunity to
display my wares.**

**That opportunity came with the
destruction of the Claws."**

I will not go into much detail regarding my background, for the obvious reason that I wish my true identity to remain unknown even today. You need only know that, although I was new to the ways of the street merc and professional soldier, I had nevertheless received extensive training in covert ops and crack assault termination techniques. How I escaped the service of my "masters" with such classified knowledge in my head is another story, whose telling must wait. Though I was more qualified by training to kill than some of those around me with greater experience, I was unproven to the powers that channeled human commerce in Stamboul. So I hung around the bars, following leads, bidding my time, awaiting only an opportunity to display my wares.

That opportunity came with the destruction of the Claws.

Those who have resided in Istanbul since 2004 are doubtless familiar with the circumstances surrounding the massacre at Clairborne Aerospace. Sampras Aerospace, a rival in aerial weapon systems, hired the Claws to launch a Grade One assault against Clairborne. The Claws were, of course, delighted to receive such a high-dollar, high-profile assignment. They assumed they'd been granted the contract because of the superior quality of their squadron.

Little did they know how carefully they'd been chosen, or for what actual reasons.

Sampras sent the Claws in against the Clairborne facility armed with faulty intelligence that greatly underestimated the strength of Clairborne's defensive forces. The Claws were unprepared for the ferocity of resistance they encountered.

Which is exactly what Sampras was counting on.

Executing a brilliant piece of subterfuge which would later become all-too-common, Sampras had set out to hire a powerful, though limited, squadron that would serve their special needs. They wanted a squadron strong enough to wreak terrible destruction on Clairborne, but not strong enough to survive the encounter.

In this way, Sampras hoped to both trash their rivals and avoid paying the bill. A crippled, broken squadron would be unable to collect on a defaulted payment, the Sampras Board of Directors reasoned. Any remaining force would be too small to contend with Sampras' own defensive wing of F-15s.

In this assumption the Board was correct. The Claws were caught off-guard by wing after wing of Clairborne Harriers. They put up a valiant fight, causing great damage to the facility. And just as the Sampras Board had hoped, the Claws lost over 95% of their squadron in the process.

When Sampras defaulted, the surviving Claws found themselves entirely without recourse. They could not collect their fee by force, since they could no longer mount a respectable assault. They didn't have enough funds to secure legal representation. Simply speaking, there was no way out. Their fee was forfeit. That was the bottom line.

So they decided to turn to the black market enforcers, the assassins, who to this day prefer to be called "contractual dispute consultants." Knowing they would never collect their fee, the last Claws were willing to settle for revenge on the Chairman of Sampras' Board of Directors.

"Executing a brilliant piece of subterfuge...Sampras had set out to hire a powerful, though limited, squadron...strong enough to wreak terrible destruction on Clairborne, but not strong enough to survive the encounter."

For a time, it appeared that even this avenue of satisfaction was to be denied them. They didn't have enough money to attract a top-rate enforcer. Too little payoff for too great a risk. Every first-rate enforcer in Istanbul turned them down, until finally in desperation they began to shop for a youngblood, an untried, unproven killer that might work for cheap.

That's where I came in.

The squadron commander had lost a great deal of weight by the time he approached me. I hadn't known him previously, of course, but I could tell as much by the way his clothes hung off his body in wrinkled bags. His was a melancholy face, sagging under the burden of a failed command, the leader's shame in surviving those given over to his charge. Dark smudges swept beneath his eyes as he handed me what he swore were the last monies he had in the world. Judging from the haunted look on his face, I believed him then. And after his

suicide four months later, I knew for a fact that he had told me the truth.

There's something horrible about a sincere concession to hopelessness. That's what this was. Instead of using

"...Sampras hoped to both trash their rivals and avoid paying the bill..."

his funds to rebuild his life, to purchase the clothes he obviously needed, or to secure simple food and shelter, this man was prepared to spend his last dollar, surrender his

final energies, in the pursuit of one last orgy of destruction. I've seen it time and again since. The sight never fails to chill my blood.

But I've never turned away, either.

Because the job was dangerous, because it was the type of operation that, if successful, might make my reputation, because I was young and eager and a bit foolish, I took that man's last dollar and agreed to be his instrument of vengeance. (I wasn't about to lecture him on what to do with his last dollar — I am not, nor have I ever been, an investment broker. I work for blood money, and a dollar that comes stained with the blood of a client will spend as well as any other.)

I had a job to do. I went about doing it.

I'll admit I was intimidated. Sampras

Aerospace was a hell of an opponent for just one man to challenge. My objective was specific enough: make an example of the President and CEO, Mr.

Dillard McDonald. How to penetrate the security net he'd cast about himself was the problem. Quite a thorny problem, for a young scram off the street. And after the initial rush of accepting this first professional assignment, I had no idea how to proceed.

Several weeks passed, during which I kicked around Istanbul, formulating a plan, searching for inspiration, that first

"When Sampras defaulted, the surviving Claws found themselves entirely without recourse."

impetus to galvanize plot into action. One afternoon, by chance, I found myself across the street from the welfare hospital in Beyoglu, where the few injured Claws still clinging to life waged their silent struggles. I decided to step inside, to see first-hand the results of Sampras' treachery.

There were two Claws in that hospital. One of them couldn't breathe without the help of a machine. His lungs were fine, but his head had been partially crushed. Part of his autonomic nervous system would never function again. Hard to believe these oddly distorted lumps swaddled in bandages and wires had once been a pilot, much less a human being, a man with a family.

His loved ones were there visiting, a wife and young son, confident as only religious families can be that he would return to them one day. At least they hadn't been saddled with the burden of the man's medical care (or, more likely, the burden of signing a death waiver — they never could've paid the hire of the life support machines) since Turkish mercenary insurance is both expensive and reliable.

Yes, the government would keep him alive for exactly one year, despite the cost, despite the fact that the man would almost certainly be a vegetable if he ever emerged from his coma. His family had hope, that afternoon, that one year would be enough for him to recover. Standing in the darkened hallway, watching quietly, I had a more realistic perspective, and it was clear to me how attractive his widow really was, and how difficult it would be to raise a young boy all alone in a city like Istanbul. I also realized that sooner or

"Knowing they would never collect their fee, the last Claws were willing to settle for revenge on the Chairman of the Sampras Board of Directors."

later, hospital visits would grow less frequent, and they would both come to

speak of the man, if ever at all, quietly, and in the past tense.

An old story. Nonetheless, a sad one. I moved on.

The other Claw I'd prefer not to speak of at any length. He was located in the burn ward. I think the figure was 65% of his body. I don't like to remember that. The horrible knowledge in the man's eyes, the screams punctuating even the slightest movements of those elsewhere in the ward, and always, that rank and underlying smell.

"This is your final payment notice, Mr. McDonald. You will remit the outstanding balance plus interest to the surviving members of the squadron you betrayed, or I will kill you."

That afternoon, when I hurried down the hospital steps, I was prepared. Ultimately, all bloodshed is personal, even when professional. I accepted that burden then, willingly, and it has served me well throughout the years.

The first step in any operation is the gathering of intelligence, research and surveillance. You use this information to determine the window of opportunity that exists for your action. Even without intelligence, however, it is necessary to begin with certain assumptions. I knew, for instance, that an all-out assault on One Sampras Square was out of the question. Any idiot who hoped to storm the building with AK-47 and grenades was kidding himself. Even if I managed to kill the president, I'd never make it back out alive.

I would have to isolate my target outside of his work environment; to accomplish that, I would need information on his personal life, his habits, daily itineraries and haunts.

This presented a problem. There was no publicly accessible information regarding CEO Dillard McDonald. No phone listings, no addresses. A birth certificate and a set of tiny prints in a

hospital file were the only evidence of his existence, other than a photo and nameplate in the lobby of One Sampras Square depicting a man who looked more like a 1950's sit-com father than a corporate monster. Even worse, there was no way I could even tail the man to gather intelligence on his habits without further intelligence! He entered and left the building by means of an underground driveway that fed into Istanbul's streets at various locations.

I found only one approach open to me. I had to bug his office. Almost as difficult as storming the building. Only slightly better odds of success. But a definite starting point.

I began to feel optimistic. I had managed to secure certain high-tech aids during my years as a covert op, aids which, if used properly, would serve me well now. An assortment of small bugs, and other more advanced equipment, all with unique assets and drawbacks. I had to determine Sampras' security precautions before deciding which surveillance system would be best. Believe it or not, that was the easiest part.

Pretending to be a corporate three-piece shopping for a security service, I rang up every security agency in Istanbul. Each security rep, eager for a new contract, was only too happy to reel off a list of current clients. When I finally hit upon the company Sampras used, it was simplicity itself to elicit a sales pitch detailing the company's most expensive and airtight procedures. Those would be the services that Sampras used. I had no doubt about that.

The news was not good. Sampras had contracted for a very thorough, twice daily building-wide sweep for particulate bugs. It was highly unlikely, given that kind of intensive schedule, that any bug I managed to place in his office would go undetected for long. A conventional listening device was clearly out.

No, obviously a phone call was in order.

I tried calling Sampras Aerospace and asking to speak to Dillard McDonald. I

didn't think it would work, and it didn't. I got as far as McDonald's secretary's secretary before running up against the expected "leave a message" stumbling block. I wasn't going to get through to McDonald on my own. I'd need help.

The next day, I went on stakeout at One Sampras Square, watching the people enter and leave the building from the street, accosting a few of them for form's sake, disguised as one of Istanbul's many beggars. So long as I stayed off the Sampras steps, I wouldn't be disturbed or noticed. Such is the state of charity in Constantinople.

There I waited, without any specific plan, hoping for nothing so much as a lucky break.

"The first step in any operation is the gathering of intelligence, research and surveillance. You use this information to determine the window of opportunity that exists for your action."

That break came when a string of limos pulled to a stop beside me. I caught a good look, between bodyguards, of well-known financier Jessup Martel walking into One Sampras Square. Destined, I was sure, for the CEO's suite.

I had what I needed.

The next morning, gear prepared, I rang up Sampras Aerospace.

"Let me speak with Dillard, please."

"Your name, sir?"

"Tell him it's Jessup Martel."

"Just a moment."

This time I bypassed both his secretary's lieutenant and his secretary. His voice was strident as he picked up the line.

"Jessup! What's the good word?"

I flipped the switch. Penetration was in the red and ongo. That was that.

"Vengeance, Mr. McDonald. That's the good word."

There was a pause. I continued.

"I'm placing this call to remind you of an outstanding debt you incurred on

behalf of Sampras Aerospace. Or have you forgotten the Claws?"

McDonald laughed. "Is this some kind of joke? Who is this?"

"This is your final payment notice, Mr. McDonald. You will remit the outstanding balance plus interest to the surviving members of the squadron you betrayed, or I will kill you."

"I see." I heard McDonald make a comment to someone else in the office, who laughed. "And who are you, then? An Angel of Death? My worst nightmare?" He laughed. I laughed with him.

"Nothing so melodramatic, I assure you. Just a working assassin hired by some people you wronged to settle a score. I'm not an angel, or a nightmare. Just someone who is very good with a knife, and who knows how ugly skinning a man alive can be. I'd consider it a personal favor, Mr. McDonald, if you would spare me that."

Anger edged into McDonald's voice for the first time. "Don't you threaten me, you penny-ante son-of-a-bitch. You pulled a cute trick getting through on this line, so consider your fee earned. We did one swell number on those Claw skags, and I know for a fact they can't be paying you near enough to take the trouble to kill me. So here's some free financial advice, pal. Take the money and walk. Otherwise, a skinning is the least of what I'll spare you."

"That's your answer then?"

"That, and this." He proceeded to request of me a physically impossible act.

"The more I came to know the bastard, the more personal my outrage became."

"I see. In that case, have a nice day, Mr. McDonald."

He hung up in my ear. But the red light on the line slicer was still glowing. Now he could hang up, make calls, or dial long distance for

all I cared. So long as I didn't hang up, I had ongo. I listened, just to make sure, but there was no need for concern. I heard McDonald loud and clear.

"The nerve of that street scam. Where does he get off, threatening me?"

Where indeed.

I placed the receiver in its ampcradle, set the recorder and cranked up the volume. The line slicer would continue to work through a fraction of the line until I broke the connection from my end, or

"I had a job to do. I went about doing it."

there was a power surge sufficient to reset the circuit. That was always a possibility, which was the reason a remote bug phys-

ically placed in an office location was a safer bet for critical surveillance applications. But so long as nothing went wrong, I'd be able to overhear every call received, and every word uttered, in McDonald's office.

I had penetrated his inner sanctum.

The more I came to know the bastard, the more personal my outrage became.

It was only a matter of days before I knew enough of McDonald's escape routes from One Sampras Square to tail him through the streets of Istanbul. Surrounded by bodyguards and opulence, he wined and dined up and down Beyoglu, from the exclusive haunts of the very rich, rising above the down-at-the-heel establishments sliding down towards the Horn, to the gambling parlors of the high-rise hotels overlooking the scenic suspension bridge that spans the Bosphorus.

The decadence that taunted me from a distance was astonishing. I was never admitted to any of the exclusive clubs he frequented, but I was able to observe one of his meals up close. This particular night, he chose to dine at an expensive restaurant which was open to the general public. With a bribe I wrangled a table next to him.

As I gingerly picked over the cheapest item on the menu, my appetite killed by the cost, I watched McDonald carelessly sample a meze, an appetizer comprising 15 separate dishes — tarama, borekler, artichoke hearts, sheep's brains. And

then, having only tasted each expensive delicacy, leaving the rest to waste as his bodyguards stoically surrounded him, McDonald moved on to the main course, imam bayildi (literally "The imam swooned" because it was so good). Turkey stuffed with currants and pine kernels, bulbul yuvasi, helva, rahat lokum, all came in wave after overwhelming wave of epicurean delight.

I couldn't finish my own small meal. The smell of the meat wafting from McDonald's table reminded me of the burn ward. His neatly pressed collar evoked the awkward lump of bandages that had once been a man, a man who had risked his life and his family's happiness for less money than this bastard might spend on a month's luxuries, and who had sacrificed his life, as it turned out, for nothing.

"I moved away, past the towering piles of garbage, and consoled myself that while life in Istanbul is cheap, it's also easy to buy."

That night, disgust sapped my energies. I had nothing left to give. I gave up tailing him. I'd gathered enough information that past week to form a plan of action, and devoted myself to finding what small cheer I could in the city's hamams. I watched his entourage pull away from the restaurant and drive into the night, past the wooden homes of Beyoglu's poor, sagging like the backlot sets of better days, the walls patched with fragments of beaten tins, or bunged with refuse, the stove-flues protruding horizontally into the refuse-choked streets, belching soot onto the heads of the miserable passersby. The wretched buildings leaned toward the street while McDonald passed, as if to beg an overriding question.

The answer wasn't worth the giving.

I moved away, past the towering piles of garbage, and consoled myself that while life in Istanbul is cheap, it's also easy to buy.

I finally identified my window of opportunity.

After following McDonald a week, I realized he was a disciplined and paranoid man, who deliberately varied even the minor details of his daily routine for security reasons, with one exception — his visits to his mistress. He was a married man, and as such, his opportunities for romantic liaisons with this woman were few and disciplined. He took only one trusted bodyguard to these weekly trysts,

"McDonald leaned close to me, his face contorted and savage. 'Damn, but I'm going to make you pay.'"

to an apartment in Stamboul's swankest quarter, where he kept his mistress in high style. Though he varied the day and time, he never varied the location or the bodyguard.

I was set. All I needed was a phone call from McDonald's suite, filling in the blanks. A time and a date, and he would be dead.

The day arrived at last. A late meeting, McDonald told his wife, unavoidable, could go on till early morning. Kiss the kids for me. Bye.

I smiled, and hoped she really did kiss the kids for him. Last chance and all. Call me sentimental. I don't care.

Then came the inevitable call to Stephanie. All set for tonight. Ten o'clock. And wear the fuzzy pink house slippers.

McDonald was one twisted perv.

I suited up. Nine millimeter Heckler & Koch, concealed under my left arm, six spare mags. Spring action holster. Dangerous without practice. However, I had practice. Lead sap gloves. Skorpion VZ 61, concealed in the expanded pocket of my greatcoat, again with spare mags. Kukri knife in my left boot. Certain exceptional precautions. I was ready.

At six o'clock, I called for a cab to take me to the Stamboul quarter where Stephanie lived. The liaison wasn't scheduled until ten, but traffic on the

acades could be horrendous, progress sometimes limited to one mile per hour. I wanted to be sure to arrive on time. I was tired of this project, and anxious not to miss any opportunity to bring about its successful conclusion.

Eight o'clock found me outside the Pera Palas, an elegant, six-story hotel near the British Consulate. I lingered on the street, reading a newspaper, soliciting the street vendors, generally assuming the role of a street skag with nowhere to go. No one noticed me.

I waited, watching the traffic pass.

At ten o'clock precisely, I saw McDonald's limo pull up to the front of the hotel.

I gripped the Skorpion, and crossed the street.

McDonald got out, turned and saw me. He watched as I pulled the Skorpion from my pocket.

That's when I felt the machine gun barrel thrust into my back.

"Easy," an unseen voice whispered in my ear.

I surrendered the Skorpion to whom-ever was behind me. McDonald smiled at me, and gestured for me to follow him. I looked over my shoulder. Six armed men stood at my back.

"I knew the Claws were losers, but to hire someone like you." He looked almost sad, then he shrugged. "Ah, well." He slapped my cheeks paternally. "Gule, gule, my friend."

"Move," one of them whispered. I complied.

All of us, McDonald and his seven goons, crowded into the lift. McDonald pressed 6. Stephanie's floor. The doors shut. He turned to me.

"So, you're the little skag who's going to skin me alive. Is that right? Eh, you fug?"

He backhanded me. I tasted blood.

"You stupid fug. You think I wouldn't detect a line splicer on my extension? You

think I don't know my business?" McDonald laughed. "I can afford to hire the best. Isn't that right, gentlemen?"

The apes behind me chortled their assent.

McDonald leaned close to me, his face contorted and savage. "Damn, but I'm going to make you pay."

The bell rang. Sixth floor. We stepped out.

Stephanie's apartment was tasteful in the same way that a whore in dim light can be attractive. If you didn't look too closely, it was pretty nice.

The decor, superficially elegant, was actually quite gaudy, lots of knick-knacks and baubles scattered around without any underlying aesthetic or logic save expense. Stephanie herself seemed like a nice enough kid, beautiful and remarkably innocent considering her circumstances, early twenties if even that. She seemed a little bewildered by this previously unsuspected side of her benefactor. She gaped, casting worried glances at McDonald, as I was ushered into the back room.

"Just stay out of this, sweetheart," I heard him saying. "I'll only be a minute."

Two goons held me by my arms, the rest covering me with pistols, as McDonald stepped into the room. He looked me over, up and down, as he might a particularly loathsome insect under glass, one whose sting could kill if encountered in the wild. He shook his head in wonder.

"I knew the Claws were losers, but to hire someone like you." He looked almost sad, then he shrugged. "Ah, well." He slapped my cheeks paternally. "Gule, gule, my friend."

"Where are you taking me?"

McDonald asked.

"To the office. You mentioned a late meeting, remember?"

As the limo pulled away, I hoped that his wife had indeed kissed the children for him.

Giving his men a nod, he left the room and shut the door.

Just what I'd been waiting for.

I hit the trigger on the inside of my left wrist.

The pressurized canister in my left pocket discharged, filling the entire room with Cyonel.

Silently, the men around me froze in their tracks and dropped to the floor, hemorrhaging silently from the mouth, eyes, ears and nostrils at the nerve toxin's merest touch. I'd taken the antidote before leaving my rooms, and it served me well now. The only effect the toxin had on me was a slight nausea from watching its effect on the others.

I waited ten seconds for the gas to dissipate before opening the door. Such a death was too quick for CEO Dillard McDonald. All his life, he'd been accustomed to red carpet treatment. I wasn't about to disappoint him now.

I opened the door. No one was there. I moved quietly through the seven-room suite until I discovered Stephanie undressing for McDonald in one of the bedrooms. She screamed and clutched at a corner of a sheet, attempting to cover herself.

"If you'll excuse me, Madame," I said, politely averting my eyes, "your lover and I have unfinished business. Don't we, Dillard?"

Prostrate at Stephanie's feet, McDonald looked up from her fuzzy pink slippers with wide eyes, speechless. I waited for him to close his mouth. In vain. I continued:

"Now, Madame, if you'd be so good as to get dressed, I'll tie you up, and we'll be on our way."

She dressed. I tied her securely, and disabled the phone rather permanently after having McDonald ring for his limo. He and I proceeded downstairs and entered the limo without incident.

"Where are you taking me?" McDonald asked.

"To the office. You mentioned a late meeting, remember?"

As the limo pulled away, I hoped that

his wife had indeed kissed the children for him.

"...Just name the price and we can all go home."

"It's not that simple," I replied, focusing.

"The hell it isn't! What else is involved in this transaction besides money?"

"Honor."

We entered the deserted office complex through McDonald's personal underground lift, bypassing all the security checkpoints except one. (To guard against him using a code-phrase to alert the guard that something was wrong, I told McDonald exactly what to say, with the understanding that if he deviated one syllable I would blow his head off.)

We stepped out of the lift and into his private penthouse office suite. I threw him down onto the carpet.

"Name any sum, and it's yours," he said.

I looked around the swank offices. I noticed the wet bar, the stereo set in its polished onyx cabinet, the flatscreen covering an entire wall and, most particularly, the video equipment in the corner which would play so large a part in establishing my reputation. On impulse, I started setting it up. McDonald edged toward his desk. I edged him right back to the center of the carpet. He swallowed.

"Come on, you're a hired killer, I know you can be bought. Just name the price and we can all go home."

"I'm afraid it's not that simple," I replied, focusing.

"The hell it isn't! What else is involved in this transaction besides money?"

"Honor."

"Fug," he spat angrily. "Stop drawing this out, damn it. Name your price."

Everything taken care of, I started the tape rolling.

McDonald turned pale as I drew my 9mm.

"Please, you can have anything you want —" The first hint of a whine was creeping into his voice. I found it grating.

"Don't beg. I told you this was coming, didn't I?" I smiled. "Gule, gule. You said it yourself."

I moved toward him. To my amazement, tears started rolling down his pasty cheeks.

"Oh God, no — no —" He curled into a ball, hands over his head. Unbelievable. There he was on the floor, whimpering and pleading for his life, this man whose merest word had brought death to so many others in the past. I was filled with profound loathing for this coward grovelling at my feet.

He deserved no mercy. None at all.

I holstered my gun, and pulled out my Gurkha knife.

"Gule, gule," I whispered, in response to his every pathetic scream.

"Gule, gule," I whispered, in response to his every pathetic scream.

I had left the videotape in the machine, along with a note to turn it on. The next morning I got up early, so I wouldn't miss anything. I fixed my breakfast as I listened to the line splicer's amplified

signal. About nine o'clock, I heard the door to McDonald's office swing open, a woman's scream, a thud. I listened to the commotion, the frantic shouting, a call to the police, the rustle of a note being read, the click of the VCR turning on. The resulting screams. The sounds of people retching.

I couldn't help but smile as I hung up the phone.

The next day, the story ran not only in the local papers, but in the national media as well. Though I hadn't intended it, I'd sealed my fate in that one videotaped action. I became a symbol, almost an icon, the unidentified enforcer committing unspeakable acts, whispering "Gule, gule." Someone used the phrase to identify me in an article, and the name held over the years, as did my trademark. The gun for the brave man, the knife for the coward. Such terrorism proved most effective throughout my career.

And now, I remain Gule Gule, retired, but ever able to spring once again into action should the need arise. I caution those corporations who would cheat the mercenaries who shed blood in their service — take care.

The payment may be dearer than you ever dreamed.

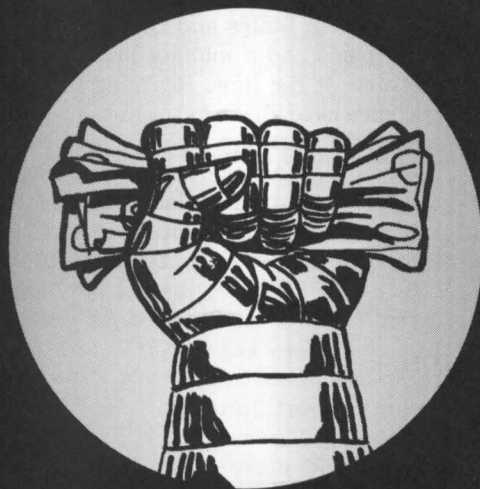

WE KNOW WHO YOU ARE!

Sure, you think you've gotten away with cheating on your taxes. No one's come around. What the hell — right?

We at the IRS know who you are. Every one of you. We know where you live — and where your kids hang out, too.

INVESTIGATIVE REPORT

"James Stern: The Untold Story"

James "Hawk" Stern is something of a legend around Turkey. There are more successful squadrons on the market than the Wildcats, but surely none of them fly so radically against the grain. Every year, prevailing wisdom holds that this man's moral scruples (some call them pretensions) will drive the Wildcats to bankruptcy, and every year Stern somehow manages to prove the conventional wisdom wrong.

After all this time, the question remains: What makes James Stern tick? No one can say for sure except Stern himself, but perhaps something can be gleaned from an examination of the public records regarding this extraordinary man.

James Stern, a native of Muncie, Indiana, was born into an upper-middle class family. In keeping with his middle-America background, Stern was from his earliest school days a patriot. Bolstered by exceptional grades, consistent leadership in extracurricular activities and the recommendation of local base commanders, Stern was accepted into Annapolis Naval Academy. It was there that he first met Jean-Paul Prideaux, a man who would be a source of both friendship and grief in later life. Prideaux was another individual possessed of leadership potential and intelligence. They quickly became fast friends and bitter rivals. Each relationship fed on the other, until the struggle came to an end after four years — Stern graduated at the top of their class; Prideaux was second.

The two men received separate assignments. Stern served aboard the carrier *Enterprise* as a naval aviator; Prideaux was posted to a naval base in Hawaii, and although the two men would not encounter each other again for many years, they apparently kept in touch.

Stern gained distinction in such diverse theatres of operation as the Persian Gulf and the Gulf of Mexico during the Texas Secession. Eventually Stern rose to the rank of colonel, and

took command of the fighter group aboard the nuclear carrier *USS Shiloh*.

The odd circumstances surrounding the loss of the *Shiloh* with all hands is still classified, but a few facts are nevertheless known. Stern was ordered by the Commander-in-Chief into battle against Alaskan forces and

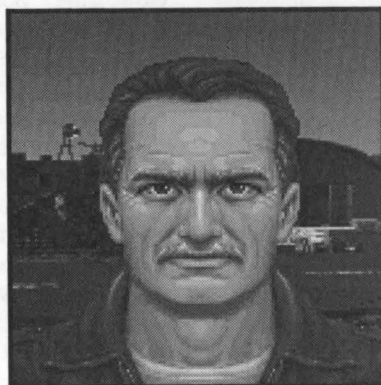

Commander James R. Stern

Alaskan allies during the PetroWar of 2001. Alaska had lined up support from Canada, the Commonwealth of Independent States and OPEC, and all three blocs had a military presence in the area at the time. Realizing this, it becomes clear that any assault against Alaska from the sea was doomed from the start. The questions concerning culpability for this disaster remain unanswered: how much did the Pentagon know regarding the disposition of forces in the region? Was Stern aware of this? And if so, was it his choice to take the *Shiloh* in, regardless of the danger?

It is unfortunate that the loss of Stern's command occurred during what would prove to be the decisive

military exercise of the PetroWar. It has been argued that this circumstance greatly magnified Stern's guilt in the eyes of his superiors, and of history. It has been likewise argued that the Pentagon never would've committed the *Shiloh* to a suicide operation, that there must have been a winning scenario behind the decision, and that Stern failed his country by failing to realize this objective. Stern himself has never commented publicly either way. Likewise, the Pentagon maintains a top secret classification around the incident, and the question will likely never be resolved until both versions of the story are told.

We do know, however, that Stern and Lyle Richards were the sole survivors of the *Shiloh*; although it is widely believed that Stern was the sole survivor, this is clearly not the case. And we can surmise from the timing that Stern's resignation from the Navy and his subsequent founding of the Wildcats sprang from the loss of the *Shiloh*. Might he have been driven into the death-for-profit business by the experience, determined to found a squadron where men, if they had to risk their lives, did it for their own reasons and profits, at the same time finding himself repelled by the ruthlessness of typical mercenary operations? Under such circumstances, the Wildcats would seem to be an inevitability, a compromise born of a troubled spirit.

For whatever reason Stern founded the Wildcats, it wasn't long before his

old friend and arch-rival, Jean-Paul Prideaux, came back into the picture. Prideaux, unlike Stern, had been too restless to settle into a military career. After serving out the obligatory four-year commission, Prideaux resigned from the Navy, hungry for independence and profit. He knocked around airfields for years, taking odd jobs for airlines and merc groups, until he finally came to Istanbul seeking out freelance work. It was there he linked up with Stern and became the first of Stern's Wildcats. The old friends were together again.

The early years were rocky. Profits were slim and jobs scarce, as the new mercenary market in Istanbul searched for its stride. Prideaux grew more and more irritated with Stern's rejection of operations he considered immoral, especially when ops were so hard to come by. Eventually Prideaux broke away from the Wildcats, forming the immensely profitable mercenary squadron known as the Jackals. This betrayal must have come as a terrible blow to Stern during hard times, and the Jackals' increasing prosperity during the years the Wildcats have struggled must give Stern doubts about his approach. Nevertheless, it is reported that the two men still communicate on a regular basis.

As to the future of the Wildcats, only one thing is clear. Stern will never compromise his commitment to morality in an immoral world. And that, at least, is something of an achievement.

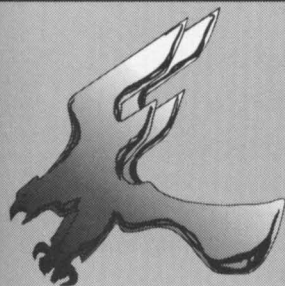

Fighting Today for Your Tomorrow!

At Fighting Falcon Insurance, we care about you. We're flying higher than ever, because the sky's the limit when it comes to your needs. Fighting Falcon offers you:

- The most comprehensive coverage on leased fighters available
- Complete packages for Squadrons and Freelancers
- Personal Life/Indemnity
- Mission Completion Bonds
- Quick, Courteous Claim Payments

We're fighting for you — but we can't win without you.

LEADER OF THE PACK

The Jackal Speaks! An Exclusive Interview with Jean-Paul Prideaux

[In the four years since their break with the Wildcats, the Jackals have become one of the ten most successful squadrons in Turkey. Such is the stuff of local legend. For the first time, hearing that SUDDEN DEATH was preparing a special Wildcat issue, Prideaux agreed to break his policy of silence. He contacted us and agreed to grant us an exclusive interview, on the condition that we'd present it in the Wildcat edition. We gladly agreed.]

"I want my side of the story to be told," he said over the phone. "No doubt, many of the Wildcats will have harsh things to say about me and my team. I wanted the chance to present my own point of view."

I met with Prideaux at his usual table in the back of Selim's, and this is the conversation that transpired:]

SD: I understand that this is pretty much your exclusive table. Is that correct?

PRIDEAUX: Yes. The management of Selim's reserves it for me each night.

SD: Am I to understand that employers actually come to you here and offer you jobs?

PRIDEAUX: You understand correctly. It's a measure of our tremendous success over these past four years. Like most mercs, I used to wander from table to table in the cafe, soliciting prospective clients, looking for work. Now, the work comes to me.

SD: Let's back up a minute. Tell me about your break with the Wildcats.

PRIDEAUX: James Stern and I go all the way back to Annapolis. Even then, he wasn't known for his practicality. He was as concerned with martial philosophies as he was with martial techniques.

SD: Yes, but he graduated Valedictorian, didn't he? And you were Salutatorian?

PRIDEAUX: (pause) Yes. I've never denied Stern's capabilities as a leader. I question his commitment to the mercenary way of life. Especially his commitment to making money.

SD: You're referring to Stern's penchant for "moral" missions. Obviously, as leader of the Jackals, you don't share his reluctance to handle... well, just about any kind of mission.

PRIDEAUX: A job is a job. I'm not oblivious to the philosophical aspect of this business. I've looked at the issues involved. The only difference is, I've come to a separate conclusion from Stern.

SD: You mean, you feel you can justify taking any mission, no matter how dirty it is?

PRIDEAUX: Absolutely. You see, conventional morality simply doesn't apply to business concerns. Evil is a useful enough concept for conducting personal affairs, but is a singularly meaningless concept when applied to the conducting of business. In any profession where death plays a factor, ethical questions are raised. But ethical questions are the forté of the philosopher and the fool, not the businessman. Evil is an act of free will. Business is a function of what the market will support. If I commit an act under contract, it is neither good nor evil, only... profit or loss.

SD: Let's go back to the split itself. Can you tell us something about how it came about?

PRIDEAUX: Well, of course, it wasn't a sudden thing. From the start, Stern told me he was determined to reject certain types of missions. Those involving murder of civilians, for instance. Those involving assaults against certain types of organizations — environmental, charity and so on. He told me these things when I decided to join the Wildcats, but I believed then that the imprecision of the mercenary lifestyle would wear him down eventually.

SD: What do you mean, imprecision?

PRIDEAUX: If you bomb, say, an industrial complex, isn't there the chance that civilian employees will be killed? How about an operation against a city? You may only target tanks in the street, but what if you miss? What if you hit a building? You see the dilemma.

SD: How did Stern reconcile these problems?

PRIDEAUX: Rationalization, I suppose. He rejected lucrative missions where civilian casualties were a certainty. He'd evaluate the merits of other missions based on gut feelings. Pathetic, really.

SD: You're saying he'd do the best he could to avoid unnecessary killing, or killing of innocents?

PRIDEAUX: Yes.

SD: But in a strictly philosophical sense, isn't that what we all do? Select a standard of behavior and then try to stick to it the best way we know how?

PRIDEAUX: All I'm saying is, in mercenary operations people are going to die. Whether they're targets or they just get in the way, the point is moot.

SD: So you don't mind killing civilians?

PRIDEAUX: Don't be ridiculous. Whenever possible, I attempt to eliminate or sharply curtail civilian casualties. But I'm certainly not going to turn hard-to-find contracts away just because the possibility of innocent bloodshed exists. No squadron can survive by turning away work.

SD: But the Wildcats have survived.

PRIDEAUX: (pause) A freak circumstance. God protects little children and fools. Anyone else would've been history. At any rate, we argued, and I resigned from the Wildcats. Several of the pilots agreed it was time to get serious about making money, and they came with me. I executed a number of quick, dirty jobs to secure capital, and then founded the Jackals. From that point on, we gained a reputation for ruthlessness that appealed to the corporate head-set. They don't want to hire mercs who entertain doubts or reservations about their work. They don't want mercs who ask, "How many people will be killed?" they want mercs who ask, "How many people do you want killed?" It makes them more secure knowing they're hiring a squadron that likes its work.

SD: Let me ask you this. In the four years since you left the Wildcats, the Jackals have gotten more and more successful, while the Wildcats have basically struggled to stay afloat, like most of the other squadrons in Istanbul. Do you see this as a vindication of your own philosophy? And what do you see in the Wildcat's future?

PRIDEAUX: There is no vindication quite like success. The Wildcats go against the grain, and in fact, I actually admire them for that. You have to admire that kind of courage, even

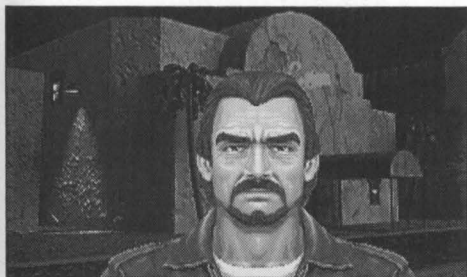

Jean-Paul Prideaux

when it's foolhardy, like Don Quixote tilting at windmills, that kind of noble insanity. Yes, James Stern and I still meet occasionally, and play a game of chess on the off-days when business is bad at Selim's.

SD: I detect a bit of fondness in your voice.

PRIDEAUX: Well. There are no friends quite so good as old enemies.

SD: Okay. Just the one question remains. What are your predictions for the Wildcats?

PRIDEAUX: They're doomed. No question. They're surviving on a mission-to-mission basis, constantly one job away from bankruptcy. Not a good basis for future prosperity. No, I predict they'll drop off the market within the next year. And I'll extend a public invitation here and now to all the Wildcats, including Stern. I will hereby guarantee any Wildcat who wishes it a position within my squadron. They're damn good pilots, all of them.

SD: You'd accept them into the Jackals?

PRIDEAUX: Provided they adhere to my standards, naturally.

SD: Colonel Prideaux, thank you for granting us this exclusive interview.

PRIDEAUX: You're welcome.

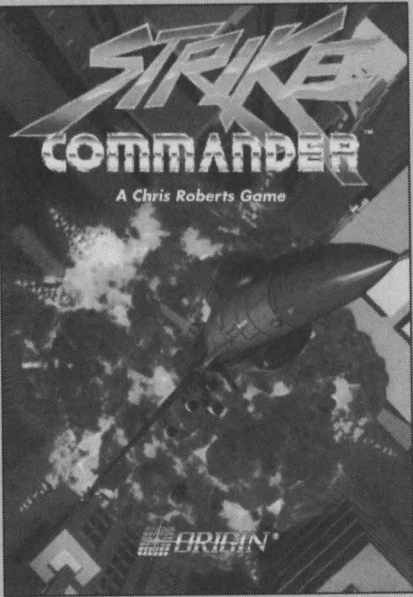

**THE ASSAULT
BEGINS
CHRISTMAS 2012!
HONEST!**



New and Improved!

**SURGEON GENERAL'S WARNING:
Quitting Smoking Greatly Reduces
Serious Risks to Your Health**

**"WE DO IT RIGHT
— OR WRONG!"**

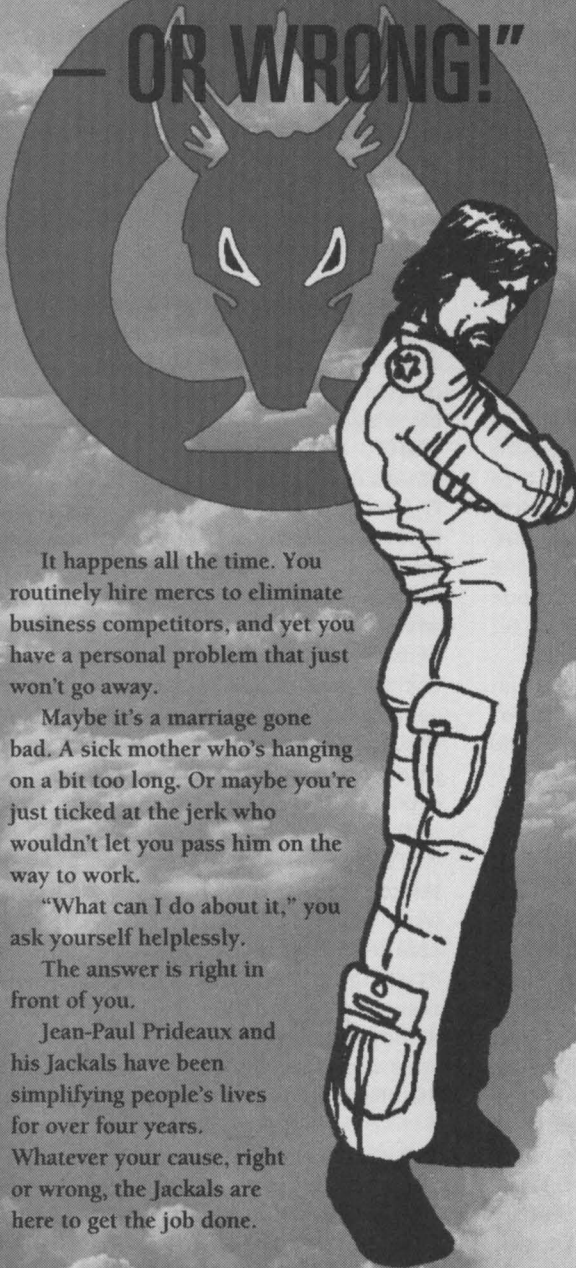

It happens all the time. You routinely hire mercs to eliminate business competitors, and yet you have a personal problem that just won't go away.

Maybe it's a marriage gone bad. A sick mother who's hanging on a bit too long. Or maybe you're just ticked at the jerk who wouldn't let you pass him on the way to work.

"What can I do about it," you ask yourself helplessly.

The answer is right in front of you.

Jean-Paul Prideaux and his Jackals have been simplifying people's lives for over four years.

Whatever your cause, right or wrong, the Jackals are here to get the job done.

**"WE DON'T CARE —
WE JUST WANT THE CASH"**



**"ONE BIG WORLD,
ONE GREAT
COMPANY"**

Pulling together for a better tomorrow is quite a task, but with you, we can make it happen. Won't you join

the TransWorld
Petrochem family?
Great opportunities exist for enthusiastic pilots with combat training who want to work in a dynamic, expanding company.

Contact:
1-800-SIGNUPP.

DECADE OF TURMOIL WINDS TO A CLOSE

Although the decade spanning 2000 — 2010 has been termed the “Decade of Turmoil” in the popular media, historians and sociologists alike are quick to dispute the label. These chroniclers point out that the upheaval which coincided with the onset of 2000 was in fact only the culmination of processes set into motion in the 1980s — the catastrophic economic policies of the United States, the conflict in the Middle East, world-wide dependence on petroleum, the collapse of the Soviet Union and the resultant rise of nationalism globally. Clearly, the events of the eighties and nineties contributed in large part to the shift in the global power structure that occurred during the 'nils — in that, the academics are correct. But from the layman's point of view, the past decade stands alone in terms of dramatic, unprecedented flux.

Despite official labels and debate, we at *SUDDEN DEATH* are united in proclaiming these past ten years the “Decade of the Merc.” In recognition of the unprecedented growth of the mercenary market, *SUDDEN DEATH* offers this summary of the major news stories of the past two decades, listing those developments that the editorial staff feels contributed to the formation of the new world order which greets us as we enter the next decade.

1992 Encouraged by the fall of the Soviet Union and the creation of the Commonwealth of Independent States, minorities in Eastern European states greet their newfound freedom with a backlash of militant nationalistic sentiment. Despite their central governments' assurances of perestroika and an official commitment to democratic and capitalistic ideals, the majority of outlying satellite states attempt to withdraw from the CIS. This

leads to minor military skirmishes throughout the CIS, as the internal stresses of intermittent conflict along several fronts prompt resurgence of hardliner support in the government, consolidation of power in a strong central government and intensification of nationalistic discontent.

1994 Iraq formally admits having a nuclear strike capability. A U.N. proclamation condemning Iraq and authorizing the use of military force against that country is issued. The United States deploys its first occupational force within Saudi Arabia since Operation Desert Storm, launching Operation Fallout, which consists of “surgical” strikes against Iraqi nuclear targets. These raids turn out to be somewhat less surgical than planned. A total of twenty U.S. “smart” missiles strike civilian populations, inflicting widespread casualties. The resulting backlash of anti-U.S. sentiment coalesces into Mideastern jihad against the Western powers. Oil exports are discontinued, and Westerners in the Middle East are slaughtered.

The U.S. retaliates with punitive strikes against Iraq and Iran. Meanwhile, with petroleum scarce, the U.S. government escalates oil production and drilling in Alaska. Accidents occur, resulting in considerable environmental damage. Alaska files a formal protest and sues the U.S. government. The lawsuit is dismissed in federal court.

1995 The European Nationalism fostered in CIS satellite states spreads to Western nations. In Great Britain, Wales and Scotland become secessionist, and terrorism flourishes. Shock waves are felt throughout the West when the English Parliament Building is destroyed by terrorist bombing during a full session on Guy Fawkes Day.

1997 Peace is restored in the Middle East as the Western powers strangle the East economically and militarily, but at a price; a majority of Eastern oil fields are destroyed, resulting in a global oil crisis. Despite strident protests by Alaskans, drilling is increased in Alaska. Additionally, a U.S. policy shift toward escalation of offshore drilling and promotion of nuclear energy is greeted by concerted environmental protests organized by militant environmental groups. The incidence of eco-terrorist acts increases over that reported in 1996 by an estimated 700%.

1998 Alarmed by escalating terrorism, and to prevent nationalism from further dividing an already unstable global power structure, the U.S., Britain and Germany commit troops to the CIS in order to assist the central government in putting down rebellion within the CIS.

2000 Western forces operating on behalf of the CIS are defeated and withdraw, leaving the CIS alone and in chaos.

The second American economic collapse begins April 16, 2000, when an international run on oil futures, exacerbated by a low dollar to yen exchange rate, precipitates "Pay Day," the worst stock market crash since the Great Depression of the 1930s. Unable to lean upon Japanese brokers for bailout as they had so often in the past, the three largest financial institutions in the West — FISCOMP, First Allied Bank and Trust, and United States Commodities — close their doors, prompting a run on all domestic banks and S&Ls. The federal government nears bankruptcy, trying to cover FDIC debts.

Meanwhile, "The Big One" finally hits California, an earthquake that destroys the Oakland, San Mateo and Richmond Bridges in San Francisco and cripples most of the freeway systems and free-standing structures in Los Angeles. California industry virtually grinds to a

halt, and hundreds of thousands are reported dead or missing. When the federal government refuses to supply disaster aid because of the financial crunch, there are riots in San Francisco and Los Angeles. California threatens secession from the Union, and the U.S. government sends in federal troops. Local resistance, however, proves fierce, and although the federal government readies sufficient power to crush California, excessive force is deemed unwise due to California's valuable natural resources, and in light of public opinion.

2001 As the Fed searches for solutions to this problem, Congress levies new taxes to compensate for the FDIC debacle. At this point, legislators, believing they've devised a solution to the California question, offer relief to California in the form of tax breaks scheduled over the next hundred years. This satisfies California.

It does not, however, suit the rest of the nation.

Texas is the first to secede, withdrawing from the Union and then splintering into three states because of fighting over debt. Then Alaska secedes, declaring itself an independent nation, shutting off the Alaskan pipeline and proclaiming their oil a national resource. Congress resolves to apply military force against Alaska in an attempt to secure the oil that is even more vital now, in light of the global petro-economic situation; in the mean-time, however, Canada has signed a mutual non-aggression pact with Alaska, recognizing Alaska's sovereignty and guaranteeing aid in the event Alaska is attacked. This conflict escalates into a multilateral, international conflict known as the PetroWar of 2001, in which the U.S., Canada, Alaska, OPEC and the remnants of the CIS wage limited non-nuclear war over Alaskan oil rights. As a result, the majority of Alaska's wilderness is set ablaze when oil fields ignite, and heavy losses are inflicted upon Canadian and U.S. naval forces.

2002 In retaliation for the destruction of Alaska, environmentalists initiate a military occupation of Yosemite National Park. This action precipitates open warfare between environmental activists and Eastern owners of Setting Sun, Inc., a foreign investment corporation that operates key tourist concerns in the park. This is the first time mercenaries are legally employed on American soil. Scandal rocks Congress, as leaders of both parties are implicated in the Bloodmoney Scandal. Allegations of misconduct are levelled when evidence is presented that congressmen used their contacts to allow the shedding of American blood on American soil at the hands of foreign concerns.

On May 1, H.R. 2343 goes into effect. The IRS gains 200,000 employees and initiates an intense campaign to collect backtaxes nationwide. The so-called "witch audits" prompt widespread civil demonstrations. Portions of downtown Washington are razed during the "Juneteenth Purge." IRS officials are accused of terrorizing the population. Resentment is manifested in riots that erupt in most major urban centers across the continental U.S.

After losses in the PetroWar of 2001, the CIS loses its status as a superpower, fragmented by the same forces assailing the U.S.: bankruptcy, internal politics and self-liberating provinces. The government solicits Japanese investment, and resource-poor Japan welcomes the opportunity, exploiting the Russians' negotiating disadvantage to invest yen at high interest rates, then foreclosing on defaults. At present, it is estimated that Japan owns 28% of Russia and the rest of the CIS.

2003 Following Texas' lead, by this year 14 of the 50 states have declared their independence. Tennessee, Mississippi, Alabama and Georgia merge into one confederation, the Southern Confederate Bloc. North and South Dakota and North and South

Carolina each merge into single states to guard against IRS predation. Regardless of state claims to the contrary, the federal government refuses to recognize the right of states to secede, and continues its attempts to levy back taxes against the secessionist factions. In its December issue, *Time* magazine pronounces civil war inevitable in a controversial editorial. Meanwhile, the U.S. government draws criticism for diverting funding from social and administrative programs to sustain ongoing military concerns.

Following the virtual bankruptcy of the United States and armed attempts by the IRS to collect additional taxes against corporations, the major multinational corporations meet in Stockholm for the First Multinational Corporation Summit. At this conference, the corporations declare their sovereignty and unaccountability to individual nation-states that engage in terrorist activities (i.e., the U.S. and the IRS). This independence is challenged by the international community, prompting corporations to invest in their own defensive forces. As a result of this initially defensive tactic, full-scale inter-corporation wars are commonplace by the year 2005.

2005 Citing executive privilege to declare a state of national emergency, President Guerrero expands the IRS and grants it rights above and beyond the constitution to collect on back taxes owed by corporations and states illegally declaring secession. The Director of the IRS hires a Dutch mercenary commando unit to help collect taxes in New York City, following a street war in which New Yorkers repel IRS auditors with automatic weapons.

Mercenaries emerge to fill this new market demand, fostered by the new martial environment. Istanbul becomes known as the mercenaries' market when Turkey grants "Turkish Diplomatic Forces" rights and privileges to mercenary squadrons, in exchange for a 10% share of their profits. Over a dozen sizable mercenary squadrons quickly emerge

within Turkish borders, availing themselves of this safe haven for their legally questionable activities.

Utilizing loopholes in international law and twisting the chaos within the new world order to their advantage, mercenary squadrons operating from Turkish bases are considered emissaries of the Turkish government, and are able to operate with relative impunity within the borders of other countries shielded by "technically creative application" of the principle of diplomatic immunity.

This immunity prevents other governments from retaliating directly against Turkish mercenary squadrons operating within their borders. Squadrons incurring the wrath of foreign nations are occasionally targeted when the offended governments put out contracts of their own in Turkey. Far from frowning upon such activity, the Turkish government considers this good for business, and diplomatically encourages vendettas whenever possible. Likewise, rather than risk their own standing defensive air forces, foreign governments and corporations begin to hire mercenaries for risky offensive missions. This arrangement seems to benefit all concerned, encouraging the perpetuation of the status quo and allowing the mercenaries to function freely in a manner that would be impossible, were it not for the latitude allowed by this liberal interpretation of international law.

Mercenary trade becomes Turkey's number one export.

Meanwhile, Nicaragua, Honduras and El Salvador unite and, proclaiming themselves a Central American Bloc, attack Guatemala and Costa Rica in a two-front war. Unrest blossoms throughout South America, as the economic collapse in the United States allows South American countries to default on U.S. loans. Unbalanced by this unexpected fiscal relief, many South American countries rediscover the luxury of war, and begin to implement a policy of invasive adventurism.

2008 When Italy's economy collapses, Vatican City expands its territories, declaring the New Papal States. The preeminence of Japan as a world power stirs Western interest in Eastern religions, converting large numbers of Catholics from the Holy Roman Church. The Pope becomes alarmed, and hires the media firm of Golan and Schwartz to combat what, to the immense relief of His Holiness, is revealed to be not so much a crisis of faith as a PR problem. Under the direction of Golan and Schwartz, exorcisms become televised regularly, birth control is allowed, and the Catholic church takes her place alongside other commercially successful cults, advertising in the *National Enquirer*.

The United States, in the truest spirit of capitalism and terrorism, begins taxing the profits of mercenary squadrons which destroy property within U.S. borders.

2011-20 **EDITORS' PREDICTIONS.** Oil supplies will continue to dwindle. The automobile will become a thing of the past for all but the ultra-elite, and gasoline will be used primarily for shipping, trucking, electrical generation and defensive purposes. Mercenary squadrons will consume a great deal of the remaining fuel, and a good 25% of their fee will be going to the procurement of oil for their operations by the end of the decade. Petrodollars will still account for OPEC's continued existence as a world power, and may enable the cartel to challenge Japan's position as the number one world power, if Mideastern oil supplies hold.

Japan will rise to a pinnacle of power entirely out of proportion to its size and resources. Eventually, not one business decision will be made anywhere in the world without crossing the desk of a Japanese executive.

Tourism in Turkey will be stifled as the recruitment and retention of professional killers gives the country a justly deserved reputation for violence and death.

WANT ADS

Wealthy programmer seeking female assassin to help dispose of ex-girlfriend. Must enjoy mixing business with pleasure. No Jennifers, please. Ask for Mighty Dog at Selim's.

Nervous fixer seeks therapist. Have been under considerable stress since the loss of my beloved fez. And I feel like invisible people are watching me all the time — Call 555-6342. Ask for Farhad.

LIKE MUFFINS? Aging Mexican fixer seeks financial backing for BETO'S ISTANBUL HOUSE OF MUFFINS. High bran content, blueberries optional. Also thinking about little footprint-shaped pancakes. Page BETO at Selim's. Most evenings.

RECITAR! Writer-turned-psychotic-assassin seeks work, preferably involving cutlery, common table salt and editors of any kind. Enjoys having work tampered with, being pushed downstairs, getting nasal passages filled with cement, and all other excuses to violently revenge self. Also into Star Trek reruns. Contact GULEMAN at Selim's.

TEST PILOT FOR HIRE: Do you believe that we shouldn't have stopped at Mach 5? Can we do better? If you've got the plane, I've got the nerve. Phone 555-FAST. Call days. Leave a message. MELTDOWN.

HELP! Desperately need to recover over 900MB of lost data from network! Respond ASAP! Call 011.49.54.21895 *** Mr Zap ***

HAWAII BIDS THE U.S. ALOHA!

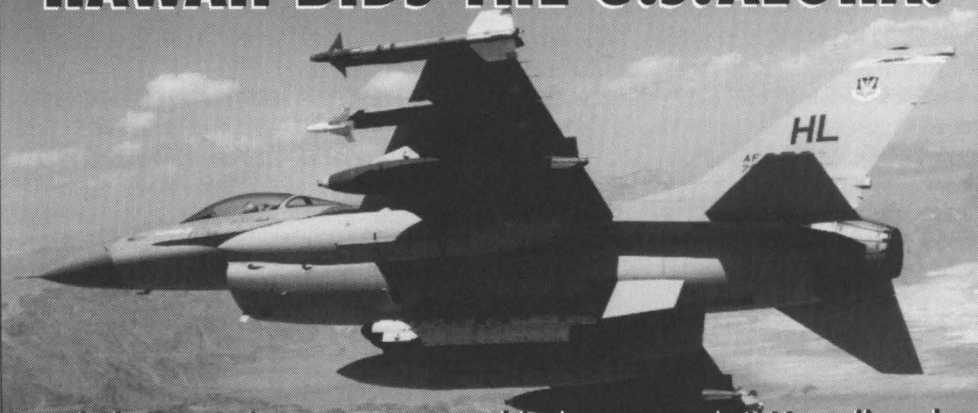

And that may just mean your ship has come in! Hawaii seeks experienced freelance fighter pilots to defend against U.S. imperialistic retaliation. All-expense paid vacations to this island paradise are included in the payment package. Call your local travel agency for details!

CONQUER
INSURANCE



Conquering The High Cost of Surviving

We at Conquer have been leaders in combat coverage for over a decade. To stay at the head of the pack isn't easy — but nothing worthwhile ever is. So while other companies rest on their laurels, we look for new ways to meet your insurance needs. Talk to your Conquer agent today about our new ELC Forfeiture Insurance Package. In the event of catastrophe, Conquer Insurance will cover up to 80% of your employer's default obligation.

Conquer Insurance — because we care.

STRIKE COMMANDER

A GAME DESIGNER'S APOCALYPSE

Recently, I watched the film *Heart of Darkness*, which chronicled the tremendous struggles that Francis Ford Coppola went through in creating *Apocalypse Now*. In many ways, the creation of *Strike Commander* has helped me identify with his plight.

It was two and half years ago, just after the release of *Wing Commander*, that I started out on what I then estimated to be a one-year project. I set out to create an industry shattering flight simulator that would encompass a revolutionary new 3-D system, a system that I planned to use for *Wing Commander III* and hoped would form the basis of a whole new generation of ORIGIN games. This system, which we later named RealSpace™, became the heart of *Strike Commander*. To make RealSpace truly revolutionary we decided to gamble on two major graphics techniques: Gouraud shading and texture mapping. Both of these techniques are used extensively on high-end military flight simulators costing millions of dollars. Their application gives rendered 3-D images a much more realistic and fluid appearance. Because of the power needed to implement such a 3-D system, nobody had previously dreamed of doing so on a PC. For us to pull this off in software, we knew we had to make some risky assumptions. First, that the power-to-price ratio of PCs would continue to decline, thereby delivering affordable PCs of adequate speed to our target market. Second, and more importantly, that the same forces that had created a demand for *Wing Commander* — those power-hungry 386 owners — would generate a demand for games that exploited the next generation of PCs, the 486. When creating *Wing Commander*, there were many who doubted the game would sell because of their lack of faith in the high-end PC market. This time, however, everyone believed in the market and, as time went on, the doubts revolved around our ability to create the engine.

In the spirit of wanting it all, we set out to design a game that would have more realism than the best flight simulator, better storytelling, more fun and more accessibility than *Wing Commander*, and the best sound effects, music and graphics of any game ever created. Our biggest mistake was thinking that we could achieve all of this in a single year. Our biggest setback was the realization that it would take more than two. But our journey had begun and there was no turning back. Perhaps the greatest heartbreak came months after the Consumer Electronics Show in June 1991. Believing ourselves to be a few months from completion, we showed a demo of *Strike* in front of the press and our competitors. Months later we were little closer to completion, but a subtle change had come over our competitors' development plans. All of the sudden, parts of the technology we had shown at CES were showing up in their software. It wasn't as if they had stolen our ideas — after all, the techniques we used to make RealSpace revolutionary for PCs are very well known in the high-end graphics field. The trouble was that nobody believed it could be done on the PC. With a single ill-timed demo, we had changed that belief and inadvertently given our competitors a heads-up on where we wanted to take the industry a full year and a half before we arrived there. During these revelations it was difficult to resist the temptation to push *Strike* out early and prevent our competitors from stealing any more of our thunder. But to stop short of our vision would have been unacceptable. We were in the middle of our journey and were determined to complete it, regardless of what lay ahead. And what lay ahead was the hardest part: long hours, short tempers and huge expectations.

In hindsight, knowing what a truly Herculean task *Strike Commander* turned into, the heartache and disappointment it created when its release date was constantly pushed back, and the amount of time from our personal lives that it consumed, we probably should have designed it differently. We wouldn't have tried to do quite as much or shot quite as high. In our arrogance we had set out to create something that was not only better than everything else, it was several orders of magnitude better. And it was several orders of magnitude more expensive as well — in fact, the most expensive game ORIGIN has ever developed. Like Francis Ford Coppola and his film crew on *Apocalypse Now*, we knew we were in way over our heads, but we also knew there was no turning back.

And now, a little humbler, we've reached the end of our long and arduous journey. We look at *Strike Commander* and see a game that every member of the team can say, "Yes, It was two years of hell, but at the end of it we've created something that is very special and I'm proud of it." I have never seen such selfless dedication from such talented individuals as the team that created it. *Strike Commander* is the game it is because of them. Each time I think about the dark circles under eyes, the unshaven beards, the late night pizzas and the neglected spouses and girlfriends, I wonder what it is that makes us do this. One reason might be that the entire *Strike Commander* team, which has grown to as many as twenty people, are all avid computer game players. We buy and play all our competitors' games, looking forward to the latest developments in our field. If we weren't writing games as a profession, we would be hating our day jobs and writing them at night. I hope this makes us as demanding and discriminating as anyone that plays our games. Although it sounds clichéd, for us it is much more than a job. I can think of no greater pride it would bring a team member than to have someone approach him at a computer store and tell him that *Strike Commander* was the best game they've ever played.

We hope you'll agree,

CHRIS ROBERTS

BIBLIOGRAPHY

- A-10 Warthog*, Dana Bell, Airlife Publishing Ltd., 1986
America's Top Guns, Gallery Books, Aerospace Publishing, 1990
American Military Aircraft, Bill Gunston, The Image Bank, 1988
The ATF Contenders: YF-22 & YF-23, Air Superiority into the 21st Century, Andy Sun, Concord Publications Company, 1991
Automatic Control of Aircraft and Missiles, 2nd Edition, John H. Blakelock, John Wiley & Sons, 1991
Bartholomew Mini World Atlas, Bartholomew, 1984
Battlefield: The Skills of Modern War, David Miller, Brian Trodd Publishing House Ltd., 1990
The Cutting Edge, C. J. Heatley III, Thomasson-Grant, 1986
Desert Shield Fact Book, The Staff of GDW, GDW, 1991
Dynamics and Automatic Control, McRuer, Ashkenas and Graham, Princeton University Press, 1973
Fighter Combat Tactics and Maneuvering, Robert L. Shaw, Naval Institute Press, 1985
Fighter Missions, Bill Gunston, Lindsay Peacock, Salamander Books Ltd., 1989
Flight Training Handbook, Federal Aviation Administration, Doubleday
The Great Book of Modern Warplanes, Portland House, Crown Publishers, 1987
The Illustrated Encyclopedia of the World's Modern Military Aircraft, Salamander Books/Crescent Books, 1977
An Illustrated Guide to Modern Airborne Missiles, Bill Gunston, Prentice Hall Press, 1983
An Illustrated Guide to Modern Attack Aircraft, Mike Spick, Prentice Hall Press, 1989
An Illustrated Guide to Modern Fighter Combat, Mike Spick, Prentice Hall Press, 1987
Incompressible Aerodynamics, Bryan Thwaites, ed., Dover Publications, 1960
Jane's Military Review, Ian V. Hogg, ed., Jane's Publishing Co. Ltd., 1986
Modern Air Power: Fighters, Stephen Badsey, Warfare/Grange Books, 1990
Modern American Fighters and Attack Aircraft, Barry C. Wheeler, Prentice Hall Press, 1987
Modern Combat Aircraft #23: Mirage, Paul Jackson, Ian Allan Ltd., 1985
Modern Military Aircraft: Eagle, Lou Drendel, Squadron/Signal Publications, 1985
Modern Military Aircraft: Hornet, Lou Drendel, Squadron/Signal Publications, 1988
Rand McNally Road Atlas & Vacation Guide, Rand McNally & Company, 1985
Russia's Top Guns, Gallery Books, Aerospace Publishing, 1990
Soviet Land Power, Mark L. Urban, Hippocrene Books Inc., 1985
Stealth Aircraft: Secrets of Future Airpower, Bill Sweetman, Motorbooks International, 1986
Strike Command at NATO's Front Line, Peter R. Foster, Arms and Armour Press, 1991
Wings, Mark Meyer, Thomasson-Grant, 1984

TABLE OF CONTENTS

Starting the Game	46	How to Fly	68
Starting a New Game	46	Flight Controls	68
Exiting <i>Strike Commander</i>	46	Mouse Control	68
Training Missions	47	Keyboard Control	68
Air-to-Ground Missions	47	Joystick Control	68
Dogfight Missions	47	Rudder	68
Object Viewer	47	Throttle	68
Game Options	48	Maneuvers	68
Option Screens	48	Taking Off	68
Configuration	48	Climb	68
Detail	48	Dive	68
Gameplay	49	Rudder	69
Cameras	49	Roll	69
Flight	49	Bank	69
Cockpit	50	Stall	69
Audio	50	Landing	69
Time Burst and Time Compression	50	Air Combat Tactics	70
Camera Views	50	Basic Fighter Maneuvers (BFM)	70
Wildcat Base	52	Combat Geometry	70
Loading Your Weapons	53	Dogfight Maneuvers	71
Barracks	54	Break	71
Loading and Saving Games	54	Loop	71
Virgil's Office	54	Lag Roll	72
Managing the Wildcats	54	High Yo-Yo	72
Strike Base	56	Low Yo-Yo	72
Selim's	57	Immelmann Turn	73
Cockpit Instruments	58	Air-to-Air Targeting	73
Heads-Up Display (HUD)	58	Medium Range	73
HUD Flight Indicators	58	Short Range	73
HUD Weapon Modes	60	Guns	73
Multi-Function Displays (MFDs)	63	Air-to-Air Evasion	74
Weapons Display	63	Long Range	74
Damage Display	63	Short Range	74
Gun Camera View	63	Guns	74
Communication Screen	63	Air-to-Ground Combat	74
Air-to-Ground Radar	64	IR-Guided Weapons	74
Air-to-Air Radar	64	Cannon and Rocket Pods	75
Threat Warning Indicator		Bombs	75
(RAW Scope)	65	Groundfire Evasion	75
Aerial Threats	65	Practice Missions	76
Ground Threats	65	Reference	79
Radar and IR Missile		Weapons	79
Warning Lights	65	Plane Specifications	82
Flight	66	Glossary	88
Aerodynamics	66	Index	90
Lift	66	Credits	93
Thrust	66		
Gravity	66		
Drag	66		
Pitch, Yaw and Roll	66		
G Force	67		
Pre-Flight Checklist	67		

STARTING THE GAME

1. First, install *Strike Commander* on your hard disk. (For instructions, see the **Install Guide**.)
2. Select the drive on which the game is installed. (For example, if you installed the game on your C-drive, type "C:" and hit **Enter**.)
3. Select your *Strike Commander* directory. (If you used the default directory, type "CD \SC" and **Enter**.)
4. Start the game (by typing "STRIKE" and **Enter**).

After a brief animated sequence, your screen will display the startup menu.

Note: If you are starting *Strike Commander* for the first time, the **CONTINUE GAME** option will not yet be available. If you have not saved a game, the **LOAD GAME** option will not yet be available.

Start New Game. To begin the full *Strike Commander* game, select **START NEW GAME** with your mouse or joystick cursor.

Training Mission. For instant action, choose **TRAINING MISSION**. You can use this customizable option to design practice missions against air or ground targets and to continue playing *Strike Commander* after you have finished the preplotted game. Although practice missions will not affect your status in the game, they are a good way to brush up on your flying and improve your combat skills while getting to know enemy planes and vehicles.

If this is your first flight simulation game, running a few custom missions before you play the main game is a good idea.

View Objects. Selecting **VIEW OBJECTS** allows you to see three-dimensional views of the planes, tanks, trucks, weapons and other objects you will encounter in the game. Use the object viewer to familiarize yourself with friendly and enemy equipment, or just to enjoy the artwork.

Load Game. To resume any of the games you have saved, choose **LOAD GAME**. When you select this option, a list of the games you have saved will appear. Select the name of the saved game that you want to continue, and click on the **LOAD** button. You will then find yourself at the point where you saved — the barracks at the Wildcat base or the tent at the strike base.

Continue Game. To keep track of your progress, *Strike Commander* will automatically save your position in the game, usually after missions or when you return to the Wildcat base. The auto-save is a backup feature, *not* a regular save function, and you can not use it to return to a previous series of missions, so be sure to use the regular save option frequently. If you exit without having saved your game, however, selecting **CONTINUE GAME** from the startup menu will return you to your most recent auto-save position. If you want to return to one of your saved games, use **LOAD GAME** instead.

STARTING A NEW GAME

After you select **START NEW GAME**, a "Mercenary Defense License Application" will appear on your screen. Enter your last name, your first name, and your callsign in the spaces provided. Press **Enter** or **Tab** to move between fields, and **Backspace** to correct mistakes.

Once you've typed text in all three fields, press **Enter** again to start the game. Your jeep will drive up to the Wildcat base, and your game will begin.

EXITING STRIKE COMMANDER

We recommend that you save and exit using the barracks and strike tent option screens. If, however, you wish to quit your game immediately, press **Alt X** to exit. This function does *not* save your game.

TRAINING MISSIONS

After you choose TRAINING MISSION from the startup screen, the dogfight background will appear, and you will be asked to choose either a dogfight mission or an air-to-ground mission. To practice dogfighting with enemy planes, choose DOGFIGHT. To practice ground attack runs, choose SEARCH AND DESTROY.

If at any time you want to return to a previous option screen, select BACKUP. You can backup as far as the first screen. If at any time you want to return to the startup menu, select CANCEL.

Air-to-Ground Missions

After you choose SEARCH AND DESTROY, you will be given a brief statement of your mission objectives and asked to confirm your choice. Selecting ACCEPT sends you to the weapons loading screen. To load weapons, click with the mouse on the weapon you want to add to your plane. The weapon will appear under the wings of your plane on an appropriate hardpoint. Weapons are always loaded onto your plane in pairs. If you click on a weapon already loaded on your plane, it will be removed and returned to the ordnance carts. (For more information on loading weapons, see **Loading Your Weapons**, p. 53.) Afterwards, select the cockpit to fly your mission or the hangar doorway to return to the startup menu.

Dogfight Missions

After you choose DOGFIGHT, you will be given a brief statement of your mission objective. At the bottom of your screen will be a set of numbered buttons. Choose the number of enemy planes you want in the first group that you will face. You will then be asked to choose the types of planes in that group.

After you choose number and type of planes, you will be given four options. If you only want to fight one group of enemies, select ENOUGH. If you want to add more groups, select MORE and choose the number and type of planes in the next group.

Once you're satisfied with the selection of enemies and the mission configuration, choose the altitude at which the engagement will begin (5,000, 15,000 or 25,000 feet). After choosing your altitude, choose whether to engage ROOKIE, VETERAN or ACE opponents. Next, you load weapons onto your plane. To do so, click with the mouse on the weapon you want to add to your plane. The weapon will appear under the wings of your plane on an appropriate hardpoint. Weapons are always loaded onto your plane in pairs. If you click on a weapon already loaded on your plane, it will be removed and returned to the ordnance carts. (For more information on loading weapons, see **Loading Your Weapons**, p. 53.) Afterwards, select the cockpit to fly your mission or the hangar doorway to return to the startup menu.

For a walk-through of a few missions, see **Practice Missions**, p. 76.

OBJECT VIEWER

When the object viewer appears on your screen, you see an F-16 as it appears in the game. Initially, the plane will be spinning. To change the direction of the spin, click on one of the ROTATE buttons with the right mouse button. To stop the object from spinning, click on one of the ROTATE buttons with the left mouse button. Once the motion is stopped, you can use the left mouse button to manually rotate an object and view it from different angles. ↑ and ↓ rotate the object around the horizontal axis of the screen. ← and → rotate it around the vertical axis.

To get a closer look at an object, press the ZOOM up arrow. To zoom back out, press the ZOOM down arrow.

To view other objects from *Strike Commander*, select the button with the name of the object you're viewing. The next piece of hardware from *Strike Commander* will appear on your screen.

GAME OPTIONS

OPTION SCREENS

Strike Commander has a comprehensive option screen interface that allows you to tailor the visual, audio and flight characteristics of the game to suit your tastes and your hardware. Activate the option screens from the cockpit by pressing **[Alt] [0]**.

Option Screens Screen

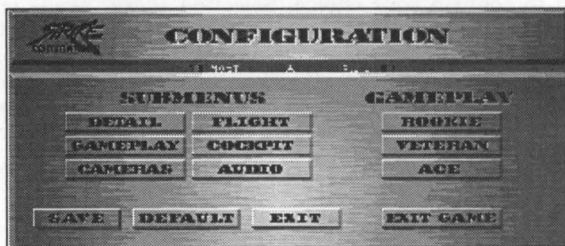

Configuration

The main configuration screen has the following buttons:

- **ROOKIE, VETERAN and ACE.** Selects the overall difficulty level of the game.
- **SAVE.** Saves your unique option package.
- **DEFAULT.** Restores the default setup.
- **EXIT.** Exits the option screens.
- **EXIT GAME.** Lets you exit *Strike Commander* entirely. Selecting **EXIT GAME** brings up a menu with the following buttons on it:
 - **RESTART.** Restarts the mission from the beginning.
 - **ABORT.** Aborts your current mission and returns you to base as though the mission had not been flown yet. This can be used to change your aircraft's loadout or to listen to the briefing again.
 - **CONTINUE.** Exits the game and returns you to the base as though the mission had been completed *at that point*. This could be used to exit the game when you know you have completed the mission goals and don't want to continue the mission to landing. This option will allow you to exit if the mission has not been completed so be sure you mean it!
 - **EXIT.** Returns you to the main configuration screen.

The other buttons are used to select the option screens listed below. For information on speeding gameplay, see **Troubleshooting**, in the **Install Guide**. If a certain button is non-functional, it means your system does not have enough memory to make it active, or that you do not have the required hardware.

Once you have configured the options to your liking, and hit **SAVE** on the main configuration screen, your game will begin with those options active until you choose to change them.

Detail

Your game automatically selects the detail settings that it considers most appropriate for your machine. However, **DETAIL** gives you fine control over the detail level of the objects and terrain by turning various textures and shadings on and off. The small window in the center of this option screen illustrates in a rough way how your changes will affect the look of the world. The less detail you select, the more rapid the game's frame rate and the smoother your game will flow (up to a maximum level). Buttons that toggle details on and off include:

• TERRAIN

- **GOURAUD.** The smooth shading of the terrain.
- **TRANSITION.** The transition texture boundary anywhere terrain color changes (for example, the transition from water to land).
- **INTEREST.** The small clumps of trees and rock outcroppings scattered on the terrain.
- **RIVERS.**
- **FIELDS.** The square patches of farmland.
- **CITIES.** The large urban areas.
- **RUNWAYS.** The textures on the runways.

• OBJECTS

- **GOURAUD.** The smooth shading on planes and other objects.
- **TEXTURE.** The texture mapping on the planes and other objects.
- **HI-LO.** Switch the objects from the highest detail levels to the lowest detail levels. There are three settings.
- **HAZING.** The distance at which the terrain hazes out. There are five different settings ranging from NEAR to FAR.

Some options will affect the frame rate (i.e., your game's smoothness) more than others, depending on your machine. Experiment with different options to get the most desirable balance of detail and speed.

Gameplay

GAMEPLAY changes the difficulty of the game in several specific ways through the following buttons:

- **UNLIMITED AMMO.** Gives you unlimited amounts of the current munitions you are carrying.
- **EASY GUN HITS.** Makes hitting enemy planes easier at long range with the gun.
- **ENEMY INTELLIGENCE.** Controls the level of the enemy artificial intelligence, with **ROOKIE** selecting the easiest enemies and **ACE** the most difficult.

Cameras

CAMERAS gives you control over the cameras in the game with the following buttons:

- **AUTO SWITCHING.** Automatically switches you back to the forward cockpit view if the plane is in danger of hitting the ground or is hit by enemy fire.
- **WEAPON CAMERA.** Automatically activates the weapon camera when a mission begins. It can also turn the weapon camera on during a mission.
- **VICTIM VIEW.** Automatically activates the victim camera when a mission begins. It can also turn the victim camera on during a mission.
- **TERRAIN IN GUN CAMERA.** Allows the gun camera to display the terrain. This reduces your frame rate, but looks better.
- **WINDOW SIZE.** Allows you to pick how much of your monitor the game screen will occupy. If you pick **SMALL** or **MEDIUM**, the screen will be reduced in size and everything on it scaled appropriately. Note that you do not lose any field of view if you pick a smaller window. The smaller the window the faster the frame rate.

Flight

FLIGHT lets you pick how you want to control the plane, the cockpit panning and other flight related items. The buttons behave as follows:

- **CONTROL.** Selects the method you use to control your plane. Any buttons that appear flat are *not* available. You may choose among **KEYBOARD**, **MOUSE**, **JOYSTICK** or **THRUSTMASTER**.
- **PANNING CONTROL.** Selects the method you use to control the cockpit panning. (As always, any buttons that appear flat are *not* available.) You may choose among **KEYBOARD**, **MOUSE**, **JOYSTICK**, **SECOND JOYSTICK**, **THRUSTMASTER** or **NONE**. The Thrustmaster choice controls cockpit panning through the thumb control on the joystick. You can always pan by pressing the second button on the joystick and moving the joystick, regardless of the control selected.
- **MID-AIR COLLISIONS.** Allows collisions between your plane and enemy planes if it is on.
- **EASY LANDINGS.** Is more forgiving to rough landings if it is on.
- **SHOW WEAPONS.** Shows you the weapon loads of all planes in the game if it is on. This option will reduce the frame rate (make the game less smooth), especially if many weapons are loaded on the planes.
- **STALLS.** Controls whether or not the plane can stall. If it is on, stalls are possible.

Cockpit

This screen lets you customize the cockpit of your plane. It can also give you tools not available in present-day aircraft, depending upon which buttons you select:

- **LADDER.** Turns on and off the pitch ladder display on the HUD.
- **TAPES.** Turns on and off the airspeed and altitude above sea level tape displays in the HUD.
- **AUTO TARGETING.** If this button is on and no target is currently selected, as soon as a target comes into range, the computer will automatically select it as a target.
- **360° LOCK.** When this button is on, you will not lose your target lock, even if the target cannot be seen by the weapon targeting it.
- **SMART TARGETING.** When this button is on, you will be unable to target friendly or shutdown aircraft.
- **SUN GLARE.** Turns on and off the glare of the sun.
- **G EFFECTS.** Turns on and off the blackout and redout effects associated with pulling too many Gs.
- **SMART RADAR.** When this button is on, the standard target blip on the radar is replaced by a series of different shapes depending upon the target's shot down status and whether or not it is friendly, enemy or neutral. For a description of these different shapes, see **Air-to-Air Radar**, p.64.
- **360° RADAR.** When this button is on, the radar switches to a mode that shows you all targets around your plane, with your plane in the center.
- **SMART RAW SCOPE.** When this button is on, all radar-emitting targets are shown at all times.

Audio

These buttons control the sound of the game. If a button appears flat, that sound option is not available with the sound card(s) you have installed. The buttons operate as follows:

- **MUSIC.** Turns music on and off.
- **SOUND FX.** Turns sound effects on and off.
- **SPEECH.** Turns speech on and off.
- **DIGITAL FX.** Turns digitized sound effects on and off.

TIME BURST AND TIME COMPRESSION

[Tab] activates the Time Burst function. Time Burst accelerates time in the game so that everything happens six times as fast. Releasing the **[Tab]** key takes you out of Time Burst.

[Shift][Tab] activates 2x time compression. Everything happens twice as fast. Hitting **[Shift][Tab]** again doubles the compression again to 4x. Hitting **[Shift][Tab]** a third time takes you back to normal time.

CAMERA VIEWS

In *Strike Commander*, you can watch cockpit action from many more camera angles than you've ever had before. With a little practice, you will be using these camera angles to great advantage.

Most of the camera views use the joystick pan technique. All but one of the camera views *replace* your HUD, so when using them, you're flying without instruments. Be advised that some of the camera views are so riveting that the development team crashed more than one plane by staying in an external camera view too long.

Never forget where your aircraft is and where it's going when you shift your view from the HUD to an external camera, and remember that **[F1]** will always snap you back to the cockpit. You will also snap back to the cockpit automatically if you come too close to the ground, take damage or stall, if you have auto-switching toggled on (see **Option Screens: Cameras**, p. 49).

- F1 Cockpit Camera.** This key snaps your eyes back to the front of the cockpit. If you are already in cockpit view, **F1** zooms the HUD in and out. You can pan (look around) your cockpit in *Strike Commander* using the joystick (with the #2 button pressed) or your keyboard, second joystick, mouse or Thrustmaster thumb joystick — see **Option Screens** (p.48) for instructions on choosing your pan control.
- F2 Chase Camera.** This is an exterior view just behind and above your aircraft.
- F3, F4 and F5 Left, Right and Back Cockpit Cameras,** respectively.
- F6 External Camera.** Press **F6** to activate this view, then use the joystick (while the #2 button is pressed) to pan around the exterior of your aircraft. **↑** and **↓** zoom in and out. Press **F6** a second time to see the next closest aircraft. **Ctrl**/**F6** cycles your viewpoint among ground objects in similar fashion.
- F7 Player to Target / Target to Player.** This camera viewpoint tracks to keep you and a radar-selected target in the field of view. The first time you press **F7**, you will see your selected target from the point of view of your aircraft. Press **F7** again to reverse the view, placing your target in the foreground and your own plane in the background.
- F8 Gun Camera.** This shows your currently selected target (for guided weapons) or a close-up of your gunsight direction (for unguided weapons). If you have a target in the cross hairs of the gun camera, your chances of hitting that target are excellent. It and the cockpit camera are the only cameras you can use and still read your HUD. The gun camera is particularly useful during combat when used in conjunction with a HUD weapons display, such as DGFT mode. It is also useful in close air support over a contested battlefield, where enemy units are intermingled with your own. It is only available from inside the cockpit.
- F9 Victim Camera.** This view allows you to see the damage your weapons inflict on a selected target, by cutting away from your cockpit to a close-up of your kill. You can preset your game (using the **Options Screens**, pp. 48-50) to automatically cut away to victim camera whenever appropriate. **F9** toggles this view on and off.
- F10 Weapon Camera.** This view follows the weapon you just launched. It is one of the more dramatic camera views. You can preset your game (using the **Option Screens**, pp. 48-50) to automatically cut away to weapon camera whenever you launch a weapon. **F10** toggles this view on and off.
- Y Auto Target Tracking.** If you have a target selected the first time you press **Y**, the camera automatically pans to keep that target in view. Press **Y** again to turn this mode off. See **Option Screens** (pp. 48-50) for more details on managing this camera.

This fluid camera view, more than any other, demonstrates the concept fighter pilots call "situational awareness"— the ability to know what is happening around you at all times. The Auto Target Tracking view lets you make fast visual assessments of the situation.



WILDCAT BASE

The year is 2011. Your mercenary squadron, the Wildcats, is struggling to survive amidst dozens of units who are as eager to find work as you are. Many of these groups, including the Wildcats, call Istanbul, Turkey, home, but your job will take you around the globe.

The Wildcat base is the center of operations for your squadron. After completing a series of missions, you will return here to purchase weapons, check the status of your squadron and talk with fellow Wildcats. From the base, you can also travel to Selim's, a bar in Istanbul, where fixers wait to offer you dangerous but lucrative missions.

Hangar Option Screen

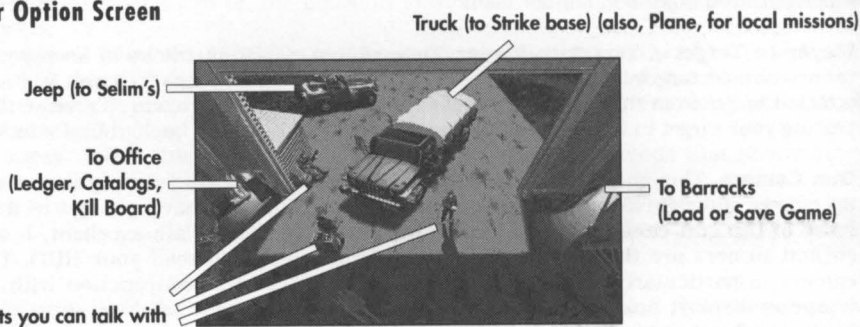

Talking to the Wildcats. You may see other Wildcats standing around the hangar. You can talk to them by selecting them with the cursor. Their conversations usually include mission information or tips on flying, so it's always wise to stop and chat.

During any conversation, you can move to the next screen by hitting **[Enter]**, **[Spacebar]** or the left mouse button. You can exit the conversation entirely by hitting **[Esc]**.

Barracks. The door to the right leads to your barracks. The barracks are one of two locations where you can load and save games. It's a good idea to save as often as possible, especially after completing difficult missions. Select the right hangar door to enter the barracks.

Office. To enter the office, select the door to the left. There, you can receive financial updates or look at the kill board to gauge your progress relative to other Wildcat pilots.

Jeep. When the jeep is in the hangar doorway, you can select it to drive to Selim's. At the bar, you can obtain missions for your squadron, speak with fellow pilots and meet other interesting people.

Transport Truck. You will be flying a variety of missions. For local missions, you will take off and land at the Wildcat base. For most missions, however, Virgil, your accountant, will make arrangements for a staging base in the vicinity of that series of missions. (Of course, a staging base adds to overhead costs, but it's a necessary expense.) After you accept a foreign mission, your transport truck will appear in the hangar entrance.

Select the truck to load the Wildcats and their equipment onto a C-130 transport plane to travel to your strike base. From there, you will begin the missions in that series.

Fighter Plane. If you accept a local mission, you will see an F-16 instead of a truck parked in the doorway of the hangar. Select the plane when you're ready to fly your mission. After selecting the F-16, you will be informed of your mission targets and flight plans. Listen carefully to any instructions — missing a rendezvous or a target can result in lost payments, expensive fighter replacement costs, or even the death of a fellow pilot. If the exact locations are unclear, however, don't worry; you will have a map in your plane's cockpit that allows you to review current mission objectives.

For the first couple of missions, Stern, the commander of the Wildcats, will assign you a wingman. As you become a more experienced pilot, you may choose your own wingman.

After the briefing is finished, the weapon loading screen will appear.

Loading Your Weapons

On the weapon loading screen, you will see your F-16 parked in the hangar (or in front of the tent, if you're at the strike base) and several racks of weapons. Some weapons won't become available until later in the game, so don't worry if there isn't a wide selection at first. Use this screen to customize the loadout your plane will carry into battle.

To load weapons. Select a weapon from the rack with your left mouse button. Weapons are added to your plane's inventory in pairs to ensure balance.

To remove weapons. Select a weapon on the plane with either mouse button, or a weapon on the racks with the right mouse button. As with loading, weapons are removed in pairs.

Weapon Loading Screen

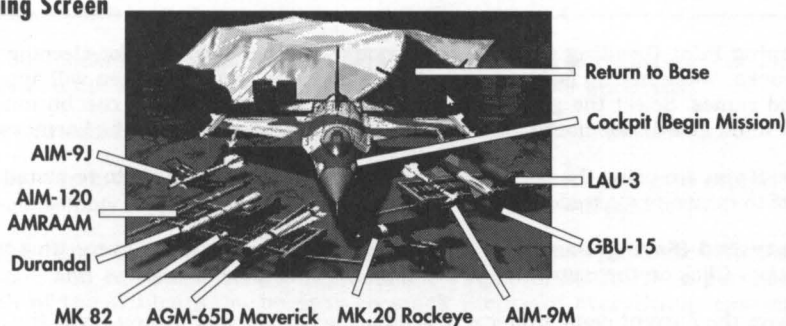

Loadout Limitations. Your plane has eight hardpoints for carrying weapons. Each type of hardpoint can carry a limited number of weapons. At the tip of each wing is a rail that can carry either a Sidewinder-9J or a Sidewinder-9M. Underneath each wing, closest to the end, is a light hardpoint. Light hardpoints can carry only air-to-air missiles: either a Sidewinder or an AMRAAM. In the center of each wing's underside is a medium hardpoint. Because they are able to carry both air-to-air and air-to-ground weapons, medium hardpoints are the most versatile. They can each hold:

- 2 AMRAAMs,
- 1 GBU-15E,
- 2 rocket pods,
- 1 Sidewinder (AIM-9J or -9M),
- 3 Mavericks,
- 3 Durandals,
- 6 cluster bombs (Mk20's) or
- 6 Mk82's.

The innermost hardpoints are heavy hardpoints. Heavy hardpoints can carry any of the weapons carried by the medium hardpoints *except* air-to-air missiles.

Returning to the Base. If you decide after the briefing that you need to check your ledger or catalog to purchase more weapons, or even if you just need to hear the briefing again, you can return to the hangar by clicking along the top of the screen.

If you wish to have the briefing repeated at that point, click on the F-16 again, and you'll go back through the briefing and the weapons loading screen.

Flying the Mission. If you're satisfied with your loadout and have a clear understanding of your mission objectives, click on the cockpit of the plane to fly the mission.

BARRACKS

Loading and Saving Games

When you're at the Wildcat base, you can visit the barracks to save the game in progress or to load a previous one. The barracks can be reached from the right doorway in the hangar.

Barracks Option Screen

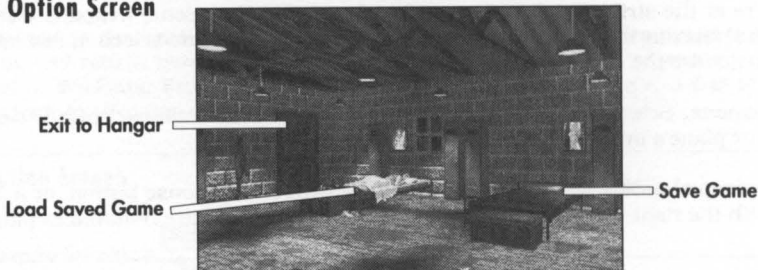

Sleeping Pilot (Loading Games). You'll notice another Wildcat pilot sleeping in a cot in the barracks. Wake her up (select her) to load a previous game. A screen will appear listing your saved games. Select the game you want to load and click on the **LOAD** button. If you change your mind and decide not to load a game, click **CANCEL** to return to the barracks.

Note: If you are using the partial installation option, you may have to re-install portions of the game to return to a saved game.

Empty Bed (Saving Games). It's advisable to save your game every time you complete a mission. Click on the empty bed to bring up the save game window.

To save the current game under a new name, select the **NEW** button. Type the name you want to use for the file and press **(Return)**. The only limit to the number of games you can save is your hard disk space.

If you choose to delete a saved game for any reason, select its name on the list and click **DELETE**. When the game asks you to verify, click **YES** to delete the saved game. Select **NO** to cancel the deletion.

If you want to save using the same name as a previously saved game, select that name and click on **OVERWRITE**. Once again, you will have to confirm your choice.

To return to the barracks, select **RESUME**. To exit your game at this point, select **QUIT TO DOS**.

VIRGIL'S OFFICE

Managing the Wildcats

Virgil is the Wildcats' accountant and chief whiner. He may be pessimistic, but it's not wise to ignore him, because he may have valuable information.

In Virgil's office at the Wildcat base, you can talk to him, check squadron finances by reading the ledger, purchase weapons from the catalog, or view the kill board to compare your progress with other Wildcat pilots.

Talking to Virgil. When Virgil is sitting at his desk, click on him to receive a fiscal update on the Wildcats. Virgil will often have important information concerning the squadron's financial well-being, so check in with him frequently.

Ledger. View the ledger by selecting the open book on the right side of Virgil's desk. The first page of the ledger shows the financial status of the Wildcats, including overhead costs, fighter plane replacement costs, recent purchases, and net worth. The statistics that are most important to you are your current cash worth and your projected overhead costs. This will be updated when you accept a mission. Remember that the overhead is a cost *per mission*.

Office Option Screen

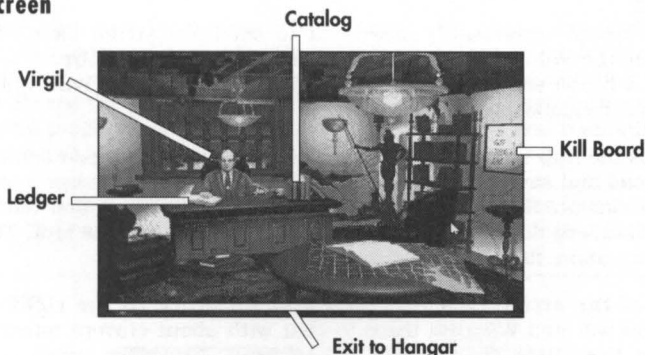

If your projected cash is ever below zero, make sure you're successful on your next few missions. Otherwise, you'll be broke, and the Wildcats will be finished.

Turn the page (by clicking on it) to see a listing of your squadron's currently available weapons. You won't order weapons here, though. Check the catalog for purchases.

To return to the office after viewing the ledger, click along the top edge of the screen.

Catalog. Initially, Stern will purchase weapons for the Wildcats. As you gain experience, however, the responsibility for purchasing weapons for the squadron will pass to you.

When it's available, you will be able to use the catalog to make weapon purchases. View it by selecting the book and calculator on the right side of Virgil's desk. You'll be purchasing weapons for all of the Wildcats, so be sure to stock plenty of everything, especially Sidewinders and smaller bombs.

When you select the catalog, it will open to two pages of weapons and prices. Flip through the book by clicking on the top corners of pages.

Buying a Weapon. Click on the weapon with the *left* mouse button. A receipt will appear on the screen with the weapon type and its price displayed on it. If you buy more of the same weapon, the number on its receipt will change.

If you change your mind and decide not to purchase a weapon, click on it with the *right* mouse button, or click on the receipt with either button. That item will be subtracted from the corresponding receipt.

Some weapons are available for better prices if they're bought in bulk. When you select one of the four weapon packages listed in the back of the catalog, you will receive the number of weapons listed in the package description. Weapon packages are a good way to save money and still buy enough weapons for the entire squadron.

As you select weapons and packages, the calculator next to the catalog keeps track of the amount of money in your account (top line), the amount you are spending (middle line) and your account balance (bottom line). You are allowed up to one million dollars in credit to purchase weapons, but remember that you will go bankrupt and lose the game if you return from a mission with no cash.

To return to the office, click anywhere along the top of the screen. When you do this, the weapons you have selected will be purchased, and the correct amount of cash will be subtracted from your account.

Returning to the Hangar. Click anywhere along the bottom of the screen to return to the Wildcat hangar.

STRIKE BASE

When you fly foreign missions, you'll need to set up a strike base. Virgil will make arrangements for the Wildcats to use abandoned airfields or old airport facilities for these bases. It costs a bit to set up a strike base, but it enables the Wildcats to fly missions anywhere around the globe.

Tent. The tent is the hub of activity at the strike base. Select the open flap to enter the tent, where you can load and save games, view the kill board, check the ledger and use the catalog. All of these functions are the same as they are at the Wildcat base. After tending to business, you may want to talk to other Wildcat pilots who are relaxing in the tent. They will give you background information, flight tips, and mission reports.

Office. Some of the strike bases include a small office to the right of the runway. Occasionally, you will find Wildcats there to chat with about current missions and strategy hints. Click on the office to talk with them. Press **[Esc]** if you wish to terminate the conversation.

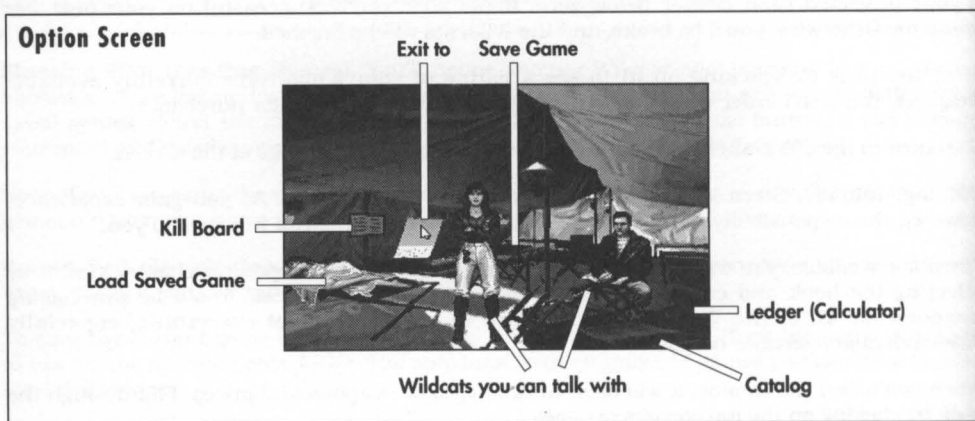

Fighter Plane. When you're ready to begin a mission from the strike base, click on the fighter plane to hear your briefing, load your plane with weapons, and fly your mission. This works the same as it does at the Wildcat base.

Transport Truck. When you've completed your work at the strike base, the transport truck will pull up outside the tent. Select it to pack up and head back to the Wildcat base.

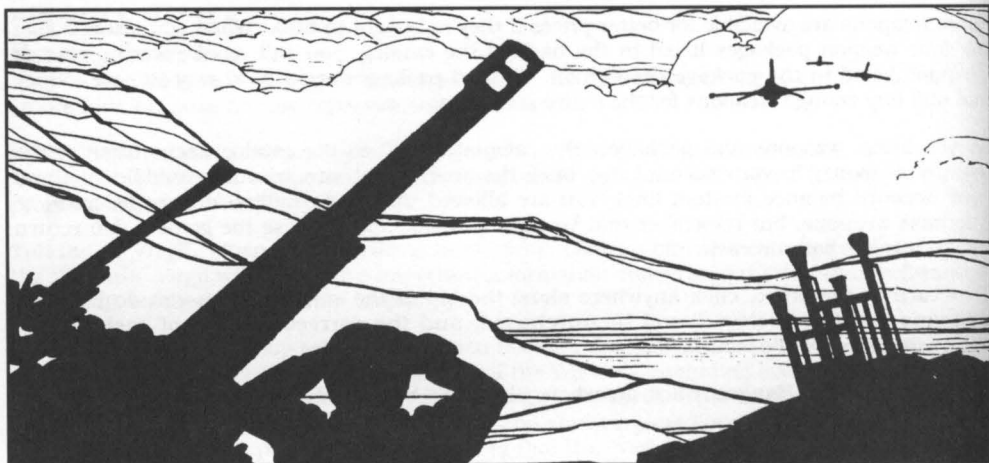

SELIM'S

The Wildcats pay the bills (and keep Virgil happy) by hiring out their squadron to governments, corporations and even wealthy individuals who need mercenary services. As a lieutenant commander in the Wildcats, it is your responsibility to contract these missions. You'll never actually see the people you're working for, though. They'll hire you through fixers — go-betweens who procure missions for mercenary squadrons and maintain anonymity for employers — for a small fee.

Many fixers in the Istanbul area frequent Selim's. You must visit the bar to talk to them and get your missions. You can also visit with other members of the Wildcats who hang out there.

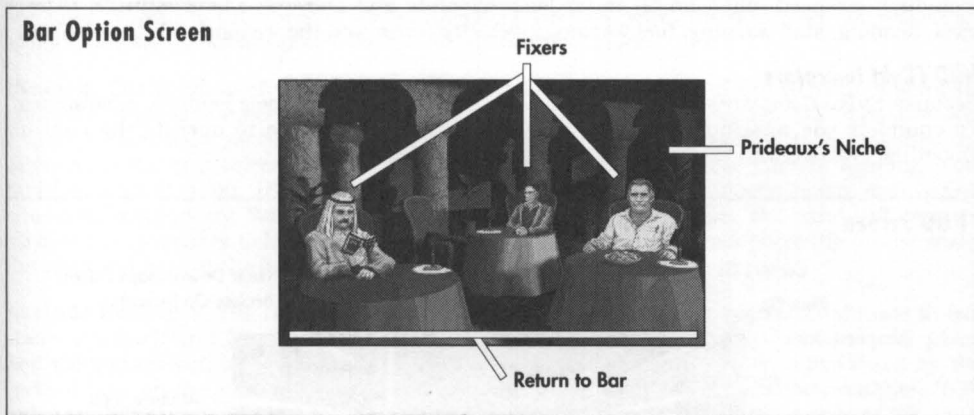

Bar. When you first arrive at Selim's, you'll find yourself at the bar. Sometimes you'll see other Wildcats there. They may have information about missions, so stop and talk to them whenever possible.

Getting Missions. Go through the archway to the right to get to the main room and talk to the fixers.

Returning to the Wildcat Base. Select the door to the left to return to the Wildcat base. Remember that if you accept a mission and leave the bar, the fixers don't want to see you again until that mission is finished.

The Main Room. Just beyond the bar is the set of tables where the fixers can be found. To hear what a fixer has to offer, select him at his table. He will present you with a general mission goal, inform you of your payment, and ask you if you want the mission. When the fixer extends his hand to shake on the deal, select the hand to accept the offered mission, or select anywhere else on the screen to reject it.

Business is slow, and it's hard to afford a good mercenary squadron, so you'll often find only one mission available. Sometimes, however, you'll have a choice of several missions. Don't be afraid to refuse a mission and listen to the pitch again, or check what other fixers have available. These guys are a competitive lot, though, and they won't take rejection kindly if there are other missions around. Refuse a fixer twice while there are other missions available, and he'll stop offering his mission to you.

Prideaux's Niche. Jean-Paul Prideaux, leader of the Jackals, holds audiences in a shadowed niche in the back of the main room. Sometimes he's there and sometimes not, but you can visit his niche by clicking on it with the left mouse button.

Once you've accepted a mission, head back to the Wildcat base and get ready to fly. With enough skill and a little luck, you'll be the top mercenary squadron in Istanbul.

COCKPIT INSTRUMENTS

The cockpit instrumentation is designed to present the huge volume of information necessary for you to fly and fight, in as readily understandable and instinctive a manner as possible.

HEADS-UP DISPLAY (HUD)

One of the things pilots like most about the F-16 is the large Heads-Up Display, or HUD. The HUD puts vital information in front of the pilot on a flat glass plate without obscuring his view ahead. The HUD displays an amazing amount of information for a single screen, including: airspeed, pitch angle, radar lock, absolute and above sea level altitude, G-force level, heading, stall warning, fuel warnings, velocity vector and the weapon sighting displays.

HUD Flight Indicators

Because *Strike Commander* closely simulates reality, it is an extremely complex environment. To complete the missions and win the game, you must be able to operate the controls smoothly. Practice with the Training Mission environment will help.

HUD Screen

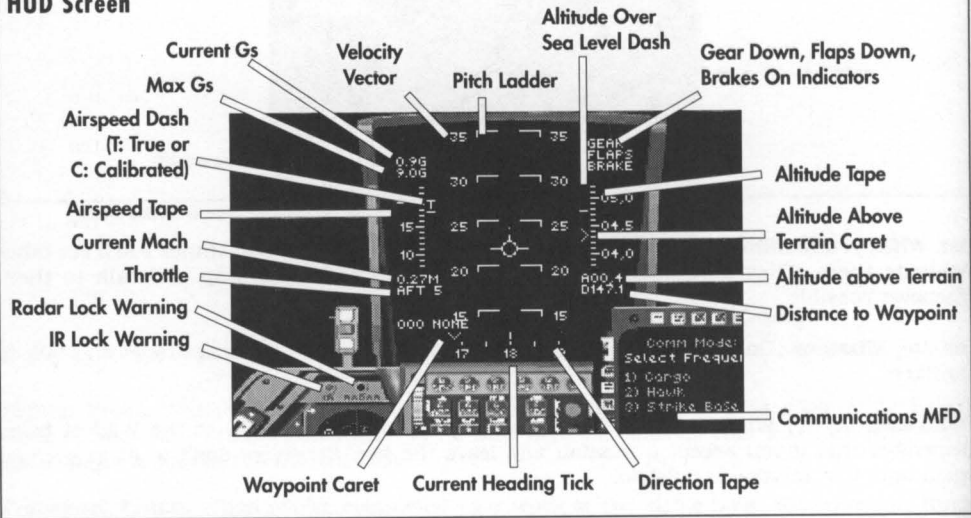

Pitch Ladder. The Pitch Ladder indicates the angle of the aircraft with respect to the horizon. As the numbers along the ladder scroll by the Velocity Vector indicator in the center, you can see how steeply you're climbing or diving, measured in degrees. This is called pitch. The ladder has a zero line with five-degree steps extending above and below, in positive and negative numbers respectively. Note that the pitch lines become dashed at negative pitch (diving).

In addition to measuring the angle of your plane's pitch, the ladder also measures angle of roll — the degree of turn relative to the horizon, known as "roll angle." If you throw the plane into a loop, the ladder will invert at the top (90 degrees) and show your descent. To ensure your orientation, the tips of the ladder rungs always point toward the horizon, indicated by the zero line in the middle of the ladder. In conditions of good visibility, some pilots turn the ladder off because it clutters up the display, but most pilots like to see graphically where they are in relation to the horizon. See **Option Screens** (pp. 48-50) for details.

Velocity Vector Indicator. The Pitch Ladder is centered on the Velocity Vector indicator, a circle with three lines projecting from it. The velocity vector shows the direction the plane is moving through the air rather than the way it is pointing. For example, if the vector mark is toward the left side of the HUD, you are moving left relative to the center line of the aircraft.

Airspeed. The Airspeed indicator, on the left side of the HUD, is a vertical strip of numbers like a tape measure. A stationary dash points to the numbers on the strip, indicating the plane's current velocity in tens of knots. Each mark on the tape indicates ten knots of speed. (For example, "35" on the airspeed tape indicates an airspeed of 350 knots.) There is a "T" above the dash if true airspeed is displayed, or a "C" if calibrated airspeed is displayed.

Using **[S]** toggles the airspeed tape between calibrated and true readouts. *True* airspeed is your speed in knots relative to the ground and is therefore a good measure of your speed relative to stationary objects. *Calibrated* airspeed is based on the velocity of the air flowing past the plane, and is thus a more accurate measure of the plane's maneuverability from moment to moment.

Mach Readout. Just under the airspeed tape is the mach readout. It measures how fast you are going relative to the speed of sound (Mach 1). Up to a point, the decreased air resistance at high altitude allows faster speeds and higher Mach numbers.

Heading. The heading of the plane is displayed along the bottom of the HUD as a scrolling horizontal tape of numbers in tens of degrees from 0 to 35. (For example, "35" indicates 350 degrees.) Each hash mark is five degrees. The caret (V) over the heading tape indicates the direction of the next selected waypoint. The stationary tick shows your current heading. Note that headings of 0, 90, 180 and 270 degrees correspond to the directions north, east, south and west, respectively. When heading directly for your next waypoint, the caret will be lined up over the stationary tick. If the heading for your next waypoint is not currently on the scale, the caret will hold at the far left or far right end of the tape.

Altitude Readouts. The HUD displays two types of altitude measurements: 1) altitude in feet above sea level, and 2) altitude in feet above ground level (the distance between your plane and the terrain you are currently flying over). The altitude readouts are represented by the vertical tape on the right side of the HUD. Each mark on the tape indicates 100 feet. "5,5" indicates 5,500 feet. There is a caret (>) and a long dash mark along the inside of the tape. The caret shows the continuous rise and fall of ground altitude, as determined by radar. The dash indicates altitude above sea level.

Note: Be very careful to watch ground altitude (>), especially when flying over mountains.

G Force Indicators. Look for the two G Force readouts in the upper left corner of the HUD. The upper number is the current G force of the plane. The lower number is the maximum G the plane is capable of. The 9G rating of a clean F-16 will be reduced by external weapon loadouts, drag due to damage or extended landing gear.

Fuel Warning. The word "FUEL" appears in the center of the HUD when the fuel supply of the aircraft reaches critically low levels.

Four-G Pull-Up Warning. The HUD displays an "X" and the words "PULL UP" if the aircraft needs to pull four Gs or more to avoid the ground at any time.

Distance to Waypoint. The distance to the waypoint selected in the Nav Map display (see **Pre-Flight Checklist**, pp. 67) is displayed in nautical miles on the right side of the HUD just under the altitude tape. This distance is prefixed with a "D".

Landing Gear Down Indicator. "GEAR" appears in the upper right corner of the HUD when the landing gear is down.

Flaps Down Indicator. "FLAPS" appears in the upper right corner when the flaps are down.

Brake Indicator. "BRAKE" appears in the upper right corner when the brakes are on. If the F-16 is on the ground, "BRAKE" refers to the wheelbrakes. Otherwise, the Brake indicator refers to the airbrake.

Stall Warning. "STALL" appears in the center of the HUD if the plane is in a stall condition.

Throttle. The throttle setting, ranging from MIL 1 (20% throttle) through AFT 5 (maximum afterburner), is displayed just below the Mach readout on the left side. Select throttle settings with the number keys (**[1]-[0]**; **[0]** is max. afterburner). To cut the engine, hit **[3]**.

HUD Weapon Modes

The most important function the HUD performs is weapon system management. The F-16 HUD in *Strike Commander* is a very sophisticated "sight" with seven modes: three for air-to-air and four for air-to-ground.

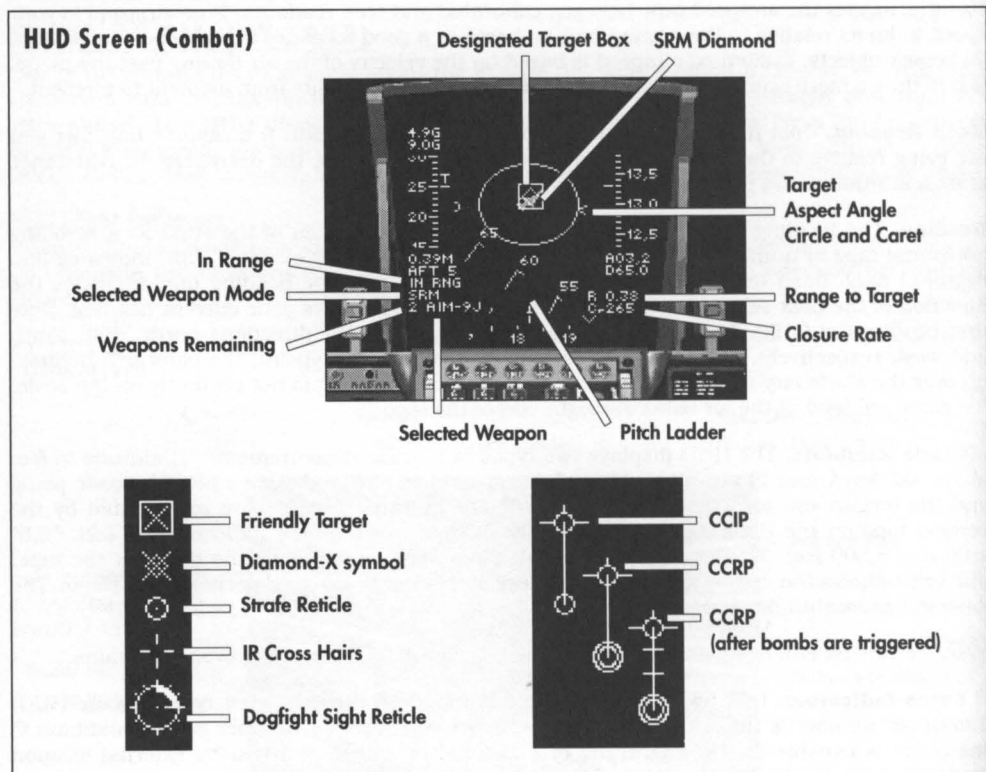

To cycle through the various weapon modes, use the weapon select key (W). (Shift+W) moves you backwards through the list.) The weapon modes include:

- Dogfight (DGFT, for the 20mm cannon)
- Short Range Missile (SRM)
- Medium Range Missiles (MRM)
- Strafe mode (STRF, used for the 20mm cannon and rockets)
- Infrared mode (I-R)
- Continuously Computed Impact Point (CCIP)
- Continuously Computed Release Point (CCRP)

In addition to the weapon modes, you can use @ to get into ACM (Air Combat Maneuvering) mode. When you activate ACM, your selected weapon will change to the cannon in dogfight mode. ACM mode restricts you to air-to-air weapons only.

Range to Target. The range to the selected target is indicated with an "R" followed by a number. The number is the range in nautical miles. This indicator appears below and to the left of the Distance to Waypoint indicator, on the right side of the HUD.

Closure Rate. The closure rate in knots (see **Glossary**, p. 88) to the selected target is displayed under the Range to Target indicator on the right side of the HUD. Closure rate is prefixed with a "C".

Selected Weapon Indicator. The name of the current weapon selected with **[W]** appears in the lower left corner of the HUD, just to the right of the Weapons Remaining indicator (see below). The weapons are: "GBU-15," "AGM-65D," "AIM-9J," "AIM-9M," "AIM-120," "MK82," "MK20," "DURANDAL," "VULCAN," and "LAU3."

Weapons Remaining Indicator. The weapons of the selected type remaining on the plane are displayed just to the left of the Selected Weapon indicator, in the lower left corner of the HUD. Note that the total number of rockets in all pods on the plane is displayed here, rather than the number of rocket pods remaining.

In-Range Indicator. "IN RNG" will appear on the HUD in the lower left corner, just below the Selected Weapon and Weapons Remaining indicators, if your target is in the effective range of the selected weapon. If the selected weapon is a "smart" air-to-ground weapon (GBU-15 or AGM-65D) the "IN RNG" indicator will appear only if the weapon is capable of maneuvering to hit the selected target.

Targeting. When you designate a target (using **[T]**), a box will appear around it. (If you accidentally cycle past a target using **[T]**, **[Shift][T]** will reverse your order through the list.) If an "X" is drawn through the box, the target is friendly (transmitting a friendly IFF signal). If the designated target moves outside the field of view of the HUD, a "diamond-x" symbol will take the place of the target box. The diamond-x will always be along the edge of the HUD closest to the target. You can turn towards the symbol to line up the target in your sights again. If, however, the box and the diamond-x symbol disappear, you have lost the radar lock on your target.

If you are in effective range for the weapon system selected, "IN RNG" will appear on the left side of the HUD just below the airspeed tape.

Dogfight (DGFT). Dogfight mode allows you to target rapidly maneuvering airborne objects with the M261 20mm Vulcan cannon. The cannon is fixed in traverse and elevation (affixed to the frame of the plane), so to aim it you must turn the plane. The real magic is in the cannon predictor gunsight.

The *predictor gunsight* places the sight reticle (or pippier) on the HUD in a position such that if the pippier were to cross the enemy plane as the cannon were firing, the shells would hit the target. To get this calculation, you must designate the target. The predictor gunsight then reads the radar data to compute the target's speed and vector relative to the firing plane's speed, vector, range and the time of flight of the shells. Since this sight automatically computes lead, there is no need to lead your target with it. Just put the pippier on the target, squeeze off a burst and you should hit, if your target continues in a straight line.

The *sight reticle* is a circle with a dot in the middle. The broad ring around the circle shows the range to the designated target. Each tick mark on the circle indicates 1000 feet. The Vulcan's effective range against aerial targets is about 1 nautical mile (6000 feet). Your closing rate should be around 0, meaning that you are flying at the same speed as your target.

Short Range Missile (SRM). SRM mode is used to aim IR-seeking missiles, like the AIM-9J and -9M Sidewinders. When you select SRM mode, a roving diamond appears on the HUD representing the seeker head of the missile. A Target Aspect Angle circle appears in the center of the HUD. This circle is centered and non-mobile in the HUD. A caret (>) rides around the circle showing the target aspect angle. For example, if the caret is at the bottom of the circle, the target is heading straight away from you. If it is on the right side, the target is headed across your course from right to left.

If you have a sound card installed, you should hear a tone that represents the search mode of the seeker head. The tone will rise and become more rapid if you have a lock. When you radar-designate a target, the diamond will drift over to it and follow it as long as the seeker head can retain lock.

As soon as the diamond floats inside the targeting square and begins to flash, you can fire. Getting a lock on the frontal aspect of a target with a -9J is nearly impossible, so maneuver behind your target before you shoot.

Medium Range Missile (MRM). MRM mode is used to lock and fire radar-guided missiles like the AIM-120 AMRAAM. The MRM display is like the SRM display (complete with Target Aspect Angle indicator), except that there is no diamond. If you have a radar lock on your target, the AMRAAM has lock. The only difference between aiming a medium range and a short range missile is that the target of a medium range missile will probably be beyond visible range (BVR).

Continuously Computed Impact Point (CCIP). Continuously-computed impact point bombing is the way most aircraft put steel on target these days.

The CCIP is a computer in the cockpit that keeps track of where a particular type of weapon will fall, given the altitude of the plane, its speed and the ballistics of the bomb. Located low in the HUD, the CCIP is represented by a circle with a center dot ("death dot"). A line extends from the dot to the velocity vector symbol ("fall line"). The "fall line" indicates the path of the weapon upon release. All you have to do is to put the "death dot" on the target and release the bombs using the trigger, spacebar or joystick button #1. It works great if the ground is level. The computer only reads your *current* altitude above ground level (AGL), so if the target is not at the same altitude as the ground beneath your plane, the CCIP will be inaccurate.

Continuously Computed Release Point (CCRP). CCRP bombing is like CCIP bombing, only more accurate. With this computer, you use a radar to designate a ground target spot. The aiming circle around the dot is a double line, to distinguish it from the CCIP. When the dot is over the target you want to hit, release the bombs. After you trigger the bombs, you'll see the fall line with a bar across it, which will descend toward another bar coming up from the death dot as you approach the target. Hold the plane steady, and when the lines meet, the bombs will release automatically. Since range to target and target altitude are known with great accuracy, it's hard to miss with CCRP. The elevation of the target is taken into account by the sight.

If you are at positive pitch when the bombs release, the weapons will be "tossed" towards the target. Note that the bars on the fall line come together faster if you climb.

Strafe Mode (STRF). Strafe mode is used to aim gunfire and rocket salvos at ground targets. It is worth noting that gun attacks on ground targets are thought of as something of a last resort by modern pilots. Selecting Strafe mode causes a simple ring and dot reticle to appear in the HUD. The dot inside the ring indicates where the rockets or cannon shells will impact on the ground. There is no radar lock for this sight.

It takes practice to get used to this mode — any pilot who can take out his ground target with rockets and guns instead of GBU's and Mavericks has earned some bragging rights. Aerial targets are a different matter, and any pilot who says he can splash other planes with unguided rockets is either lying or very, very good.

Infrared Mode (I-R). Infrared mode is used to aim Mavericks and GBU's. The target of the missile is covered by a cross hair on the HUD which moves between the ground targets as you cycle through them by pressing **[T]**. When a missile or guided bomb locks on a target, it will retain the lock as long as it can, subject to the plane's maneuvers.

Since Mavericks and guided bombs are not very maneuverable, wait until an in-range message appears on the HUD to launch your weapon. The best attack profile is to fly straight and level at high altitude, designate the target and release the weapon. Be advised that this tactic is suicide against modern air defense installations.

MULTI-FUNCTION DISPLAYS (MFDs)

There are two multi-function display screens in the cockpit. They can both display any of several useful types of information, including air-to-air radar, communication interface, air-to-ground radar, damage display, target view, gun camera, and weapon hardpoint display. If you activate an MFD by mistake, **[Esc]** will cancel the display.

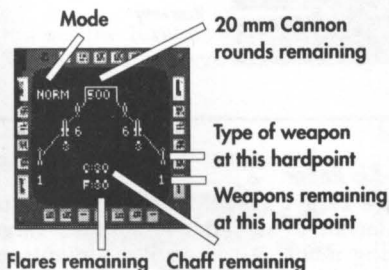

Weapons Display

The Weapons display comes up on the MFD when you select a weapon (**[W]**). The selected weapon will be boxed on the display. The number under each hardpoint indicates the number of weapons left in that position. As weapons are used (or as hardpoints are blown off the plane), they vanish from the MFD. Exception: Rocket pods remain on the MFD unless they are jettisoned.

Damage Display

The Damage display gives you an overhead view of your F-16. Destroyed systems are red. Always use this display to check your landing gear for damage before attempting to land. If you can't land, point your bird somewhere safe and eject. The fuel remaining in the plane's tanks (measured in kilograms) is displayed in the upper right corner of the MFD.

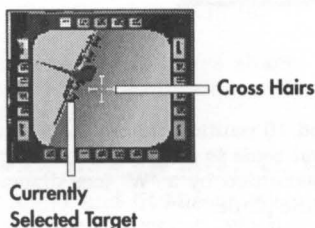
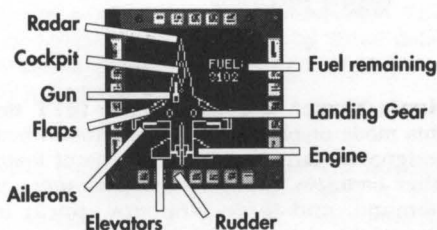

Gun Camera View



The Gun Camera View MFD (**[F8]**) shows a view of your currently selected target. It will display a close-up view if you are within 15,000 feet (2 or 3 nm) of the target. It is the only camera view you can use and still read your HUD. The gun camera is particularly useful during combat when used in conjunction with a HUD Weapons display, such as the DGFT mode. It is also very useful in close air support over a contested battlefield where enemy units are intermingled with your own.

Communication Screen

The Communication Screen MFD serve as the means of radio communication between you and the other characters in *Strike Commander*. To open the communication interface, hit **[C]**. The MFD displays a list of possible channels. One channel gets you the Wildcat base (or strike base), another calls your wingman, and so on. Use the number keys (**[0-9]**) shown next to the channel you want to make the call.

After you select a channel, the MFD will change to list the messages you can send on that channel. Select the message you want to send using the number key corresponding to the number to the left of the desired message. (Note that throttle control is not accessible while the Communication Screen is active, because the number keys are used for both.)

Air-to-Ground Radar

Air-to-ground radar shows objects (including runways) on the ground, unless they are blocked by terrain. As you get closer to the objects shown on the screen, they will get closer to the bottom of the screen. The number at the top of this display is the scale of the view. You can zoom in from normal view, through 2x, 4x, 8x and 16x steps, to a 32x magnification, using  (larger) and  (smaller).

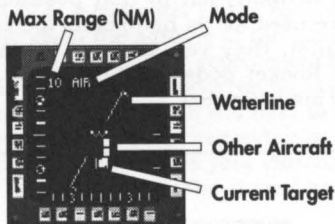
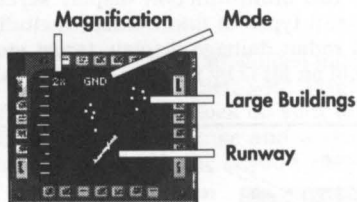

Air-to-Air Radar



Multiple Target Tracking Mode. The default mode for air-to-air radar is Multiple Target Tracking mode. All targets are displayed as square blips. The closer the blips are to the bottom of the screen, the closer they are to you.

Targeting Mode. When you select a target, it is designated on the Radar MFD by brackets.

Single Target Tracking Mode (STT mode).

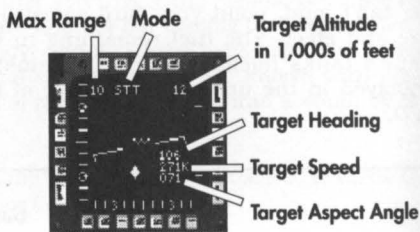
This mode displays more information about the designated target at the expense of losing all other contacts. The target blip changes into a diamond, and three numbers appear in the lower right corner of the MFD. The top number is the heading of the target. The middle number is the speed of the target in knots. The bottom number is the target aspect angle with respect to your plane. STT mode also allows you to see if an enemy is finished or not. If an opponent is gone for good, his diamond in STT mode will turn into an outline.



The air-to-air radar can operate in four scales: 80, 40, 20 and 10 nautical miles. Zoom in and out using  (larger range) and  (smaller range). The current scale is displayed at the top of the MFD. Across the center of the MFD is a pair of lines separated by a "W" (see diagram). These lines are called the watermark and indicate the roll of the plane.

Enabling the "smart" radar function in the option screen interface (see **Option Screens**, p. 50) lets the radar discriminate between friendly, neutral and enemy contacts. Neutral contacts appear as circular blips, enemies are squares and friendlies are triangles. Shot-down contacts appear as outlines of circles, squares or triangles.

The 360-degree scan mode in the option screen interface (again, see p. 50) lets the radar scan all contacts around you. In this mode, the closer the contact is to the center of the screen, the closer it is to your plane.

THREAT WARNING INDICATOR (TWI, OR RAW SCOPE)

The TWI is located to the left of and below the HUD. It is a passive radar emission receiver composed of an antennae network and computer-enhanced signal analysis equipment, located in the skin of the plane. It determines the direction, intensity and type of radar waves striking your plane at all times. It then displays this information in the form of icons. The position of the icons on the display correlates with the hostile radar's direction and distance from your plane. The icons will "rotate" around the display when you turn.

If you set the RAW scope in "smart" mode using the option screens (see **Option Screens**, p. 50), all radar emitters will be displayed, whether they are facing your aircraft or not.

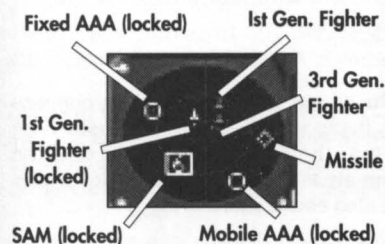

Aerial Threats

The TWI also shows rough distance. As a rule, if you can see it on your threat display you can turn towards it and see it on the radar. Triangles represent enemy planes. There will be one to three dots along the base of the triangle; the number of dots indicates the "generation" of the fighter whose radar is illuminating your plane. Primitive radars, or first generation, will have one dot. There aren't many primitives still flying in 2011, but you never know. Two dots in the triangle indicate a second generation radar. The most advanced radars are represented by three dots. Air-to-air missiles (and radar-guided SAMs) are represented by a diamond.

Ground Threats

Ground-based missile radar is represented as a square with a number inside it. The number denotes the numerical designation of the SAM most commonly associated with it. For example, an SA-6 radar will show up as a little square with a "6" in it. Gun radar is represented by a circle. A dot in the circle indicates a fixed AAA; a circle without a dot means a mobile AAA gun is down there.

Remember, while airborne radar will be located on a plane, ground-based radar can be remote from the weapons it operates.

Regardless of the icon's shape, if it suddenly glows brightly, the radar in question has switched from acquisition mode to tracking mode. A bright icon means a hostile radar is tracking you!

RADAR AND IR MISSILE WARNING LIGHTS

The Radar and IR Missile Warning lights are located just above the TWI (Threat Warning indicator) in the cockpit. When a missile is tracking you, the light appropriate to the missile's guidance system will come on. The red (right) light indicates a radar-guided missile has locked on to you, while the yellow (left) light denotes an IR-guided threat. (IR recognition technology was developed in 2004.)

FLIGHT

AERODYNAMICS

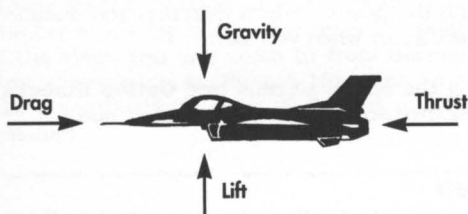

Strike Commander accurately simulates real atmospheric conditions. Therefore, it will be to your advantage to understand the physics of airplanes: those forces that produce, affect and control flight. Don't worry, you know a lot more about physics than you might think. As a pilot, you will be most concerned with four forces: lift, thrust, gravity and drag.

Lift

Lift is the force produced by the airflow over and under the wings. In level flight, lift opposes gravity and takes the plane off the ground. (If the plane is flying upside down, lift pushes the plane *towards* the ground!) The faster the plane is moving, the faster the airflow and the greater the lift. At high altitudes, lift decreases because the air is thinner and less flows over the wing at any speed. Larger wings produce more lift, but also cause more drag.

Thrust

Thrust is the force exerted by the engines of the plane. The plane's thrust divided by its weight yields the thrust-to-weight ratio. If thrust-to-weight is greater than 1, the aircraft can accelerate straight up.

Gravity

Gravity is a constant force that pulls the aircraft towards the ground. It is usually countered by lift. If you're flying straight and level, gravity and lift are in balance.

Drag

Drag is the force that results from moving an object against the friction of the air. It is the force opposing thrust, just as gravity is the force opposing lift. The balance between a plane's thrust and its drag determines its top speed. Like lift, drag decreases at high altitude because the air is thinner. Planes with large wings and high lift tend to have more surface area and thus encounter more drag. A large wing also produces more drag in a bank than a small one, so planes with large wing areas tend to bleed off speed in banking turns more quickly. Air-to-ground weapons, deployed landing gear and airbrakes all cause more drag and slow the plane down.

PITCH, YAW AND ROLL

Aircraft can maneuver in three different ways: pitch, yaw and roll.

Pitch. If the plane is flying with wings parallel to the ground, pitching means moving the nose of the plane up or down by pushing the control stick (joystick) forward or pulling it back.

Yaw is moving the nose side to side by using the rudder keys (□, □).

Roll is spinning the plane around an imaginary line running from nose to tail by moving the joystick right or left.

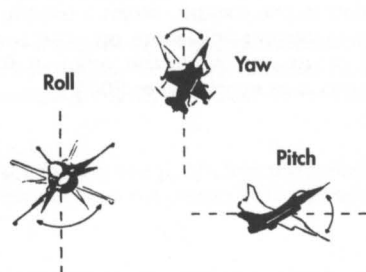

G FORCE

A "G" is a measurement of pull, or force, equal to the force exerted by the Earth's gravity on a stationary object at sea level. If the pull on your body suddenly became twice as strong, you would be experiencing two Gs. Fighter pilots routinely take five Gs or more in a dogfight.

G forces can be divided into two types: positive and negative. Positive Gs pull you relatively downward, and negative Gs pull you relatively upward. When you are upside down, your relative up is pointed toward the ground, and the Earth's gravity is pulling you with 1 negative G.

When you experience positive Gs, you feel like you are getting heavier. This effect is caused by banking or climbing sharply or by ejecting from the plane. At several positive Gs, the force pulls blood away from your brain and optic nerves, causing loss of color vision (grayout) and eventually blackout. In *Strike Commander*, too many positive Gs turns the screen monochrome, and then black if you continue to add Gs.

Negative Gs have the opposite effect, making you feel lighter, and forcing blood into your head and the capillaries of the retina in the eye. The elevated blood pressure causes your capillaries to swell and/or burst. This results in a reddening of the vision called "redout" by pilots. In *Strike Commander*, too many negative Gs turns the screen red.

An adult human can take 8 to 9 positive or 2 to 3 negative Gs for a few seconds with no permanent damage. Five positive Gs is bearable for a couple of minutes. The ejection seat of the F-16 generates around 30 Gs, but only for a fraction of a second. Because of the difference in tolerance between positive and negative Gs, most pilots prefer maneuvers that induce positive Gs, like climbs and inverted dives.

PRE-FLIGHT CHECKLIST

Get in the habit of always performing a pre-flight check. The more choices you make now, the fewer you will have to deal with when the bandits are swarming.

- Verify your weapons loadout.
- Choose a weapon targeting mode on your HUD (W).
- Choose and activate your camera views.
- Flaps on. Brakes off.
- Set your air or ground radar to an appropriate range scale.
- Check your Nav Map (N). Find the target area and figure which heading will take you there. Locate any mountain ranges you could use to screen your approach to the target. Use the arrow keys to switch the destination of the autopilot. The current destination will appear in white text on the map, while the other areas will be in green.
- Compute fuel for return trip. The best way to compute the amount of fuel available for a mission is to subtract 10% from your beginning fuel load and divide the remainder by two. For example, if you have 1000 kg of fuel at the start of a mission, subtract 100 kg (10%) and divide the remainder (900 kg) by two, yielding 450 kg. Fix that number in your mind. Check your fuel level periodically during the mission and turn for home when you reach the "bingo" point. The 10% emergency reserve will become critical if you miss the landing approach, or if you have to hit the afterburner one last time to disengage from combat.
- Set up option screens (see **Option Screens**, pp. 48-50).



HOW TO FLY

FLIGHT CONTROLS

Strike Commander can receive flight control input from a mouse, keyboard or joystick. In addition, it supports the Thrustmaster flight control interface. See the **Reference Card** for more information on the Thrustmaster. You can select the flight control device of your choice in the FLIGHT menu of the **Option Screens** (p.48).

Mouse Control

Pushing the mouse away from you pitches the plane down, and pulling it toward you pulls the nose up. Moving it left or right banks the plane left or right. The left mouse button fires the selected weapon. If the mouse has only one button, it fires the selected weapon.

Keyboard Control

The arrow keys (either on the number pad or the main keyboard) control pitch and roll. ↑ pitches the plane up, and ↓ points the nose down. ← and → roll the plane left and right.

Joystick Control

A joystick is the suggested flight control interface for *Strike Commander*. Pulling the stick back (towards you) points the nose of the plane up, and pushing it forward (away from you) points it down. Moving the stick left or right rolls the plane left or right.

Rudder

⌂ and ⌄ control the rudder, and thus the yaw of the plane. Note that ⌂ and ⌄ are also ⌃ and ⌅, so it's easy to remember which one yaws the plane left and which one right.

Throttle

The number keys control the engine throttle setting. 1 represents 20% thrust from the engine, 5 is 100% military power (full power without afterburner). 6 through 0 are afterburner settings. For example, 6 is full military power plus 20% afterburner. Bring up the Damage MFD (D) and set the throttle at 5. Observe the fuel readout in the upper right corner of the MFD. Now punch up full afterburner. Note how the rate of fuel consumption goes up. If you stay on 'burner all the time, you'll run out of fuel before you complete your mission.

MANEUVERS

Taking Off

Put your flaps down (F), put the brakes on (B), and punch up full afterburner (0). When your plane starts to move, release the brakes and taxi. When your speed indicates 115-125 knots, the velocity vector on the HUD will rise above the zero pitch line. (This is called *rotation*.)

Now pull back slightly on the stick to get into a nice steady 15 to 25 degree pitch angle, raise the landing gear, retract the flaps, and there you are. Don't try to climb too fast. A stall here would be lethal. Throttle back unless you have somewhere to go immediately; the afterburner guzzles fuel at 12 times the normal rate.

You can use the auto takeoff feature by hitting A. Relax and watch the plane leap into the air.

Climb

To climb, pull back on the stick. If you're travelling too fast when you start the climb, you can pull too many Gs and experience grayout. If your airspeed is too slow and your pitch angle is too great, you can stall. In an optimal climb, your speed should be about 450 knots and your pitch no greater than 35 degrees.

Dive

Nosing over into a dive from level flight at combat speeds often results in too many negative Gs and subsequent redout. Since your rate and angle of dive are restricted by negative Gs, it is often better to do an inverted dive. Roll your plane 180 degrees so that your cockpit is facing the ground and pull back on the stick. This maneuver allows you to dive toward the ground, yet pull positive Gs.



Rudder

The rudder is most often used when you want to keep wings level and would rather not roll into a bank (see below). Good times to use the rudder are on final approach to landing, or to fine tune a precision attack run.

Roll

A roll is the simplest maneuver of all; you'll do it without realizing it after a while. With the plane flying straight and level, move the stick to the right or left all the way. The plane will spin around its long axis. Try not to depend on the ground to gauge your position — use the HUD. Now try to roll more slowly and stop the roll at some point, like at 90 degrees (one wing pointed straight up, the other straight down). Rolls are important because you can pull out of a roll in any direction, to shake an opponent.

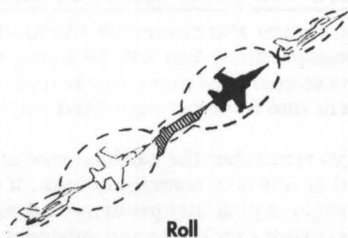

Bank

A bank is a roll to the left or right, then pulling back on the stick to change your heading. Most turns in a dogfight are banking turns, since you can use the lift of the wings and their larger ailerons to come around faster than a rudder turn.

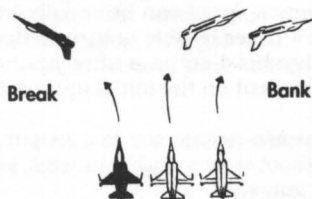

Stall

Every aircraft has a critical angle of attack. If you exceed the critical angle, your wings will no longer produce lift (due to turbulence), and the control surfaces will not have enough airflow across them to function. You will begin to fall. This condition is called a stall. You have no control of the attitude of the aircraft in a stall, so in combat, stalling is tantamount to suicide. Your plane will hang there, out of control, as the enemy blasts it apart. If you are too close to the ground, you can't fall far enough to get your airspeed back, and you'll catch hill disease.

Common maneuvers that can trigger a stall include tight turns that lose too much velocity, loops with insufficient airspeed, take offs and landings. The slower you are flying, the more likely you are to stall.

RECOVERING FROM A STALL. If you stall too close to the ground, eject. How close is too close? That depends on how you got into the stall and how good a pilot you are. If you decide to ride it out, remember the controls will be sluggish from the low indicated airspeed. Once you drop below 500 feet, it's time to think about punching out. Just don't think too long.

If you went into the stall in a high nose-up attitude (pointing at the sky), cut the engine (☐) and wait for the nose of the plane to swing back in line with the velocity vector. This will probably point you straight at the ground. Punch up full afterburner (⓪) and bring your airspeed back up to around 120 to 150 knots. Now pull the stick back slowly to come out of the dive. If you went into the stall pointing roughly at the ground, just keep the engine on and dive until your airspeed comes back up, then pull out and start recovering the altitude you just lost from the stall.

Landing

The easiest way to land is to use the Auto-Landing function. Simply get back to your base area and hit [A]. But that isn't much of a challenge, and if you want the full *Strike Commander* experience, you must know how to perform a manual landing you can walk away from. First, check the Damage MFD (ⓐ) and make sure the landing gear are intact. It's embarrassing to line up the perfect approach and not have any landing gear left. You have to line up with the runway in level flight and about 2 nautical miles out. Try to be lined up when the runway just becomes visible, or target an object at the near end of the runway to get an exact readout. Give yourself plenty of room. Now cut back the engine power and pull back on the stick to pitch the nose up slightly. The object is to lose altitude at a rate which will put you on the runway at the end of your glide path and not in it. As your wheels are about to touch (the chase plane camera view is a great help to landing technique), pull the nose up a little more, cut the throttle and hit the brakes when you touch down. It takes a lot of practice to land safely, so don't get discouraged. Try it in the Training Mission area until you get it right.

AIR COMBAT TACTICS

BASIC FIGHTER MANEUVERS (BFM)

Basic Fighter Maneuvers are the fundamental moves that trade speed and altitude for relative aircraft position. You will be flying in either a defensive mode or an offensive mode. Your offensive goal is to maneuver behind your opponent and take a shot. Your defensive goal is to prevent him from getting behind you and/or move out of his firing range.

Always remember the cardinal rule of air combat: Speed is Life. All maneuvers cost you either speed or altitude, sometimes both. If you use up too much speed in a maneuver, you lose the chance to exploit any positional advantage you gained by the maneuver, as well as the option to disengage quickly if your opponent outguesses you.

Too much speed can be equally lethal. If your closure rate is much over 1000 knots, you will almost never be able to turn in time to establish a pursuit situation. You will have to settle for another head-on pass after you both get turned around. In general, faster than 500 knots is not prudent on the initial approach unless you want to get in one fast pass and run away.

If you are closing too fast in pursuit of another fighter, you could overshoot the target. An overshoot is very bad because it leaves you at close range with the enemy in a perfect position for a gun shot.

This section tells you *how* to perform the maneuvers, but perfect *timing* requires practice, experience and an ability to judge relative high speed motion. The best aces develop timing by learning to execute the maneuvers flawlessly, recognizing them quickly and by surviving ... and so will you.

Combat Geometry

Lag Pursuit, Lead Pursuit, Pure Pursuit. Air combat is most concerned with predicting the enemy's future position. Early in your approach, you need to make some predictions about your enemy and some critical decisions about how to pursue him. "Early" means just before you reach maximum weapons range. BFM training defines *pursuit* as where the nose of your plane is pointed in relation to the enemy. *Pure pursuit* occurs when your plane is pointing directly at the opponent. Even though you may be in front of the enemy, if your plane is pointing at him, you are in pursuit. If the nose of your plane points behind the enemy, you are in *lag pursuit*. Use lag pursuit if you want to end up behind your opponent. If your nose is pointing in front of the enemy, you are in *lead pursuit*. Use lead pursuit for gun passes and closing the range on your enemy.

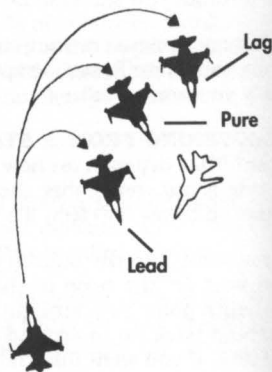

Turn Radius. The F-16 has the best maneuverability of any plane in the game except the F-22. Airspeed of 450 knots allows the smallest turn radius, an important advantage during dogfights. The F-16 also loses less speed in a turn than many of the other planes in the world.

Target Aspect Angle. Target aspect angle is measured from the tip of your aircraft to the tail of your enemy. This angle tells how many degrees you are from being lined up behind the target.

Deflection. The *deflection* of a shot is the amount of lead you must use to hit your target with a dumb projectile. Deflection is usually measured in degrees. The higher the deflection angle, the more difficult it is to hit your target.

By definition, all gun shots are taken from the lead pursuit attitude. This means the nose of your aircraft is pointing at the future position of the target. In lag pursuit, on the other hand, your nose is pointing behind the current position of the target, ensuring that a gun shot will not hit its target. If your current maneuver depends upon holding lag pursuit, don't use the

gun. Conversely, if you're the one being fired upon, it might be time to pull a hard break away from the enemy to give him a high deflection shot and spoil his aim.

Required deflection angle is calculated automatically by the radar driven predictor gunsight on the F-16, but you need to be aware of the pursuit angle changes the sight will impose when you use it.

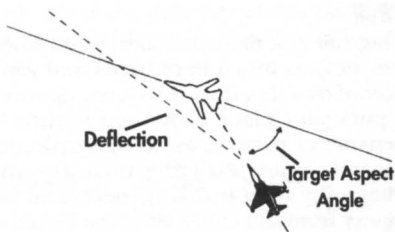

DOGFIIGHT MANEUVERS

You must enter every dogfight with the confidence that you will survive it. Your primary objective is to position your plane directly behind your opponent and stay there long enough to blow him away. Get to know these basic maneuvers and corresponding counter-maneuvers so well they are second nature. Be in tune with your opponent to the extent that you can accurately guess his future position. Choose a maneuver but be flexible, ready to modify it as your opponent tries to foil your setup. Remember, the enemy is reacting to your moves with the same focus and skill that you are reacting to his.

If you have trouble executing any of the dogfight maneuvers, switch to External Camera view (**F6**) as you do them and practice making them look similar to the diagrams.

Break

A break is a bank away from another plane's bank (see diagram, p. 69). If an opponent follows you into a rolling chase, wait until his plane is rolled opposite yours and pull for all you're worth. Now do it again in the opposite direction as you see him follow you into the first bank. With any luck, you can put enough distance between your aircraft and his that you can continue the last break into a full turn and use the F-16's superb turning characteristics to get out of his sights and onto his tail. Just remember: Speed is life! If you have to pull more than one or two high-G breaks to get the guy off your tail, you've probably used up all your speed advantage doing so. An *opposition break* occurs when two planes break across each other's courses simultaneously in order to separate quickly.

One of the best responses to an opponent's break is the lag roll. Alternatively, follow the break around and set up lag pursuit. Try for a missile or gun snapshot.

Loop

The loop is a good basic maneuver to master, because it tends to be a part of more complicated maneuvers. It is a climb or dive held until you circle back to where you started. An inside loop keeps the canopy of the aircraft on the inside of the loop, and an outside loop puts it on the outside. Since vertical loops cost so much speed, they are rare in dogfights. However, many maneuvers begin with partial loops. If nothing else, mastering the loop prepares a pilot for the disorientation and big G forces of inverted flight at high speed.

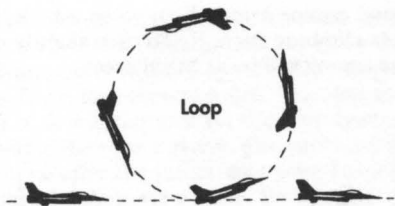

Countering the loop is easy. Bank hard around and try for a high deflection shot as the other plane dives for the deck. Your enemy might try to turn the loop into an Immelmann, but if he does he'll be going so slow at the top that he'll be an easy kill.

Lag Roll

The lag roll is a maneuver best used when your opponent goes into a hard break and you are in danger of overshooting. It reduces closure speed and puts your plane above and slightly behind the enemy in position for a high deflection gun or missile shot. Pull the nose up slightly, moving away from your opponent, and begin to roll away from the direction of the break. As you do this you will lose sight of the enemy momentarily. Don't worry. When you roll all the way over so the top of your HUD is aligned with the enemy, pull down towards him. You should have bled off enough airspeed that you will no longer be in danger of overshooting, and your inverted position above and out of the geometric plane of the target should give you a visual fix on him. If you lose your target or can't find him below you, roll upright and look up. There's only one place he can be, and odds are he will be lining up a missile or gun shot.

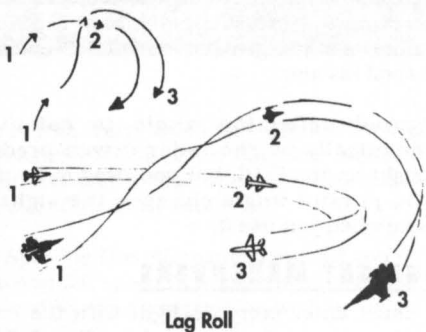

Lag Roll

The proper response to the lag roll is to climb over the rolling attacker and/or loop to get a decisive shot.

High Yo-Yo

The high yo-yo is a maneuver designed to decrease closure rate and set up a strong shooting position for guns or short range, rear aspect missiles. It starts with both aircraft in the same geometric plane, and with your enemy banking hard across your course. Instead of turning with the enemy, establish lag pursuit and pull your nose up and out of plane in a climbing bank in the direction of your opponent's bank. At the mid-point of the turn, when you see you have the position, point the nose down and dive-turn onto your opponent's tail. Since you bled airspeed with the climbing bank, you should be able to turn inside your enemy and end up above and slightly behind him with a better angle than you started with.

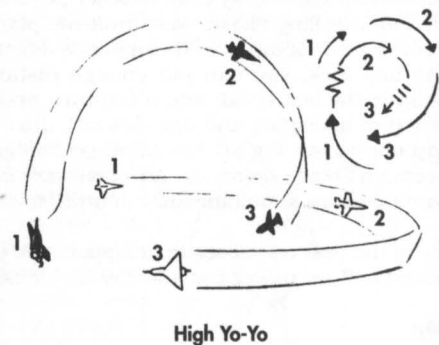

High Yo-Yo

A good escape from a high yo-yo attack is to reverse your bank as your attacker hits the apex of his climbing turn. If you dive slightly as you do this you won't lose too much airspeed, and your enemy will be at his slowest.

Low Yo-Yo

A low yo-yo is the opposite of a high yo-yo. Where the high yo-yo seeks to decrease closure rate, the low increases it. Where the high is executed at close range, the low is performed further out. The target aspect is the same: about 90 degrees across your course. From a lead pursuit position at moderate range in the plane of the target, roll into his bank and dive slightly to keep your speed. If you can establish enough excess lead angle to allow it, climb back to the target's geometric plane. You can get low deflection, short range shots with this maneuver if you time it right. The key is having sufficient excess lead angle at the bottom of the diving bank.

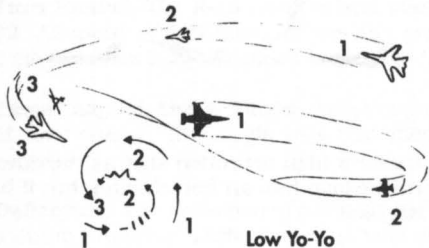

Low Yo-Yo

Countering the low yo-yo involves reversing your bank when the attacker starts his dive. If you reverse and climb, you'll have a huge altitude advantage in the next phase of "negotiations."

Immelmann Turn

Immelmanns are a flashy way to reverse direction. Pull the fighter into a climb, and when you go over the top and become inverted, roll the aircraft upright and center the stick. You gain altitude and reverse direction at the same time. You will also lose many knots of airspeed. But if you've got an enemy on your tail, this move will put you in a head-on position. The best way to counter an Immelmann is to climb with your target; don't let him get too much of an altitude advantage.

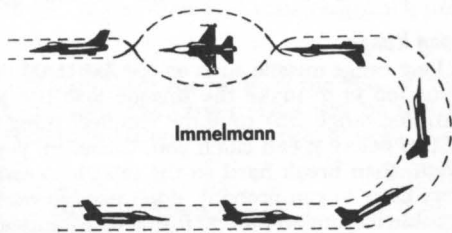

AIR-TO-AIR TARGETING

The primary objective of air combat is to shoot down your enemy with as little risk to yourself as possible. Your weapon choices for air-to-air combat are medium-range AIM-120 AMRAAMs and short-range AIM-9J and -9M Sidewinders. Your primary concerns when launching missiles are: the speed you are travelling, the speed of the target and the target aspect angle. Some air-to-air weapons are classified as "all aspect," meaning they can engage the target no matter which way it is headed relative to you. Guns are considered all-aspect weapons. Some weapons are rear-aspect-only, meaning that you must fire them from behind the target. All-aspect weapons are easier to use, and are usually more expensive.

The section below is a "how to" guide for the air-to-air weapons in *Strike Commander*.

Medium Range

The AIM-120 AMRAAM is the only radar-guided AAM in the Wildcat arsenal. It is highly maneuverable, has a very accurate semi-active radar guidance system with computerized target discrimination and a range of 2 to 40 nautical miles. The long range of the AMRAAM make it ideally suited for BVR (beyond visual range) engagements. Using the AMRAAM is simple: Launch at the furthest range possible (but no more than 30 or 35 nm) and climb slowly toward your target. If the AMRAAM misses, you need to put yourself in a good position for the ensuing close range fight. You could also launch and turn around in order to assess the effects of the weapon while keeping the enemy at arm's length.

Short Range

The AIM-9J and -9M Sidewinders are short ranged infrared homing missiles built for use in dogfights. The -9J is a rear-aspect-only weapon. The seeker head has to lock on the engine heat of the target, so you have to get the position advantage on your target in order to get a solid lock. The -9J is also vulnerable to distraction by flares and even the sun. The -9M is an all-aspect weapon, so you can take frontal shots with it. It will not lock on the sun (having a more sensitive seeker head) and is less prone to mistake a flare for a plane. The problem with both missiles is that there is no way to ensure they will go after the target they were launched at if there is another viable heat source (another plane) in their view cone. Be advised that firing a Sidewinder close to a friendly plane is risky.

Guns

The F-16 comes equipped with the M61A1 20mm Vulcan cannon. It will serve you well in the heat of a chaotic dogfight. It fires 100 20mm shells every second. One in five of these rounds is a tracer, so you can see where the fire is going. The range of this weapon is only about 4000 feet, but its enormous rate of fire makes it lethal within that range.

AIR-TO-AIR EVASION

No matter how good you get, eventually somebody is going to get on your six and hang there like a rabid pit bull. The plane you fly is valuable and so are you. You have to know how to prioritize and evade threats at all ranges. Remember: You have to be ready for anything, because you will not know what the other guy has until he shoots it at you.

Long Range

A long-range missile such as the AMRAAM depends upon maintaining a radar lock. Therefore, your job is to make the missile lose the lock on your plane. If you detect the launch at extreme range (35+ nm), the simplest thing to try is turning around. The missile will run out of fuel before it can catch you. Closer in, you should try to get turned around and drop some chaff, then break hard so the missile doesn't just fly through the cloud and re-acquire you. Very close in you probably don't need to worry so much about AMRAAMs, since they will have trouble turning to hit you inside of 2 nautical miles or so.

Short Range

You have a bit less time to evade the short-range Sidewinders. The -9J is not nearly as accurate as the -9M, and if you can draw it into the sun you can shake it. It's pretty hopeless to try and shake either of these missiles with maneuver. But since both are IR homing, you can try to divert them by releasing flares, cutting the afterburner and breaking, or by flying close by another aircraft and passing them — an enemy aircraft, unless you want to run out of friends.

Guns

Since guns work best with a small deflection angle, maintain a relative angle of greater than 45 degrees to your opponent. Try to minimize exposure to your underside and topside as you engage in the dogfight.

AIR-TO-GROUND COMBAT

Ground attack missions pose a different type of problem: target acquisition at high attack speed. The eye can distinguish a main battle tank at around a mile in full daylight, 100% visibility. At 450 knots, an F-16 will cover that distance in ten seconds. You will be within range for everything except bombs in six seconds. You will have that time to see the target, select it (or line up the dot if you're on a bombing run), maneuver and take the shot. Many attack runs are executed at greater than 450 knots to minimize exposure to enemy anti-aircraft systems, so you may have even less time.

IR-Guided Weapons

The AGM-65D Maverick and the GBU-15 are guided by an imaging infrared seeker. These are two of the most expensive weapons you can buy, so an accurate approach and delivery technique is critical.

Get a radar lock on your target (use \square). Approach low, flying straight and level, at an approximate altitude of 300 feet. At 1 or 2 miles from your target, begin climbing above 500 feet while maintaining speed. Launch when the crosshair drifts over the target and the "IN RNG" note pops up in the HUD. Extend into a hard break and hit the afterburners. Check your rear hemisphere for missiles and drop decoys if you're being pursued. Remember that the Maverick and the GBU-15 have very little maneuverability and their true range is determined by the speed and altitude you are flying at when you launch them.

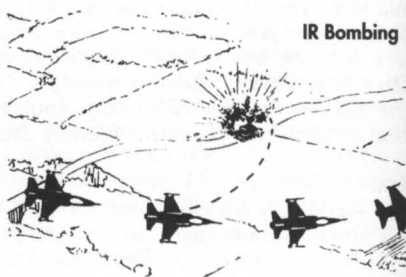

Cannon and Rocket Pods

Use the Strafing mode gun sight. Fly low (below 500 feet) and level. The most dangerous aspect of cannon fire is the close range at which you can effectively hit your target. At 6000 rounds per minute, you can deplete your ammunition quickly, so experienced pilots will shoot in short bursts, saving the continuous "walking" fire for when you're directly over your target and about to pull up. Do not get fixated on your target. If you didn't hit your target, it'll just have to wait until your next pass.

Rocket pods work the same way, but they have more than twice the range of the gun, so you can open fire sooner. As always, try to avoid flying over the target. This will be nearly impossible with a gun attack, but you might have time to break off after a rocket attack.

Bombs

You can use the CCRP or the CCIP. The CCRP is best in hilly country because it takes target altitude into account. Many pilots prefer the simplicity of the CCIP, and it's a fine sight if the ground is relatively level. After all, if you wanted to put it through a window, you'd have used a GBU-15, right? With a stick of 500-pound bombs, you just have to get close.

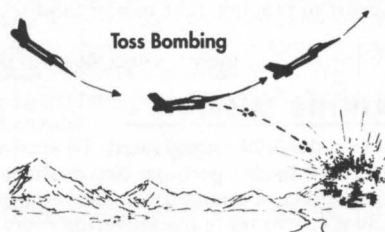

Approach the target from as high an altitude as you can, given the air defense situation. It's easier to line up for a bombing run if you don't have to worry about contracting hill disease. Usually, around 500 feet is the bare minimum. If you have to come in lower, you may have trouble acquiring the target in time to attack effectively. Get roughly lined up by banking and make the fine adjustments with the rudder. Put the dot on the target and trigger the bombs. If you use the CCRP, you'll have to stay on target for a few more seconds until the bombs release, and you should pull up steadily until they do, using the flight path of the plane to "toss" the bombs at the target. After release, turn away and try to leave the target area the same way you came in. There might be SAMs or AAA on the other side of the objective. Try not to drop your whole load on the first pass. Even the good bombers miss every now and then. Use half and come around for another pass if you have to. Durandals work the same way, but their natural prey is a runway or landing strip. On a Durandal run, try to come in at a slight angle across the strip, since if you try to line up directly down it, you will miss with everything if you are even a little off center. You have to fly over the target with Durandals, because of the way they fall.

GROUNDFIRE EVASION

You will face two kinds of AA in *Strike Commander*: Missiles and guns.

Missiles. Countering SAMs is almost like evading AMRAAMs. They are radar guided weapons, and should be chaffed and/or turned away from. The best way to handle them is to kill the launcher (Mavericks are good for this). The SAMs in the game tend to be a little slower than the AMRAAM, but that means that even though they may not catch you quite as fast, they turn better. They also carry huge warheads, so ditch them if at all possible.

Guns. High speed and altitude are the keys to evading AAA. If you have to stay low, kill them outside their range with a Maverick. Failing that, try to keep hills between you and them. Failing that, they will cut you apart quickly.



PRACTICE MISSIONS

If you want to get in a little practice maneuvering, dogfighting, and bombing without the added pressure of managing a fighter squadron, here are some good practice missions to get you in the air on your own. Soloing is a special event in a pilot's career. It's the first time you have the sky all to yourself, with nobody around to blame if things go wrong and nobody looking over your shoulder. There's no reason to be too hard on yourself at first. Follow the advice given below and go easy.

Note that these missions all begin with you in the air, at the beginning of the engagement. If you want to practice take offs or landings here, find a runway away from the combat.

From the startup menu, select TRAINING MISSION.

TRAINING MISSION 1

Choose a dogfight engagement. To start with, select a group of less maneuverable targets who won't shoot back : perhaps two or three C-130s, Lear jets, or AWACS. When you've chosen a small number of one of these plane types, select ENOUGH, select an altitude — probably 25,000 feet, to give you more maneuvering room — and continue with the weapon loading screen.

When the weapon screen comes up, load your plane with air-to-air weapons. A good practice load would be 4 AIM-9Js and a full gun load. Click twice on the AIM-9J (to the left of your screen) with your left mouse button. You will see the missiles appear on your wingtips and under-wing light hardpoints. Your plane already has loaded guns, so click on the cockpit to put your plane at the beginning of the engagement.

G Force. Practice flying past the target, then bank hard and come back at it quickly. Watch the Gs. Pull enough to begin blacking out, then back off. Note how fast you were going and stay just below that speed during combat. Remember, you can survive several times more positive Gs than you can negative.

Maneuvering. Roll the plane in the direction you want to go and pull back on the stick to head that way. Now, drop in behind the target and try to match speeds. It's tough isn't it? Hang in there!

Pursuit. Try using the air brakes and flaps to increase drag and dump speed. Once you have a feel for how fast your enemy is going, you can match speeds with him and hang on his tail until he makes a mistake.

Select Weapon. Select a Sidewinder-9J (W). Your best offense is rear-aspect missiles. After mastering these cruder -9J missiles, using the newer, more sophisticated ones will be a breeze.

Radar Lock. Press (T) to get a radar lock on your target. Shoot him, then shoot him again for good measure, since the AIM-9Js warhead is quite small and probably won't kill a big plane in one shot.

Select New Weapon. Now switch to guns (G) and press (T) again to select the next target. Be sure your target is in range before firing. Compared to other plane-mounted cannons, the Vulcan has the highest rate of fire but only a very short range. Within 3500 feet you can expect hits, and within 2000 feet, you can expect kills. Try not to hose the gun around. It fires at 100 rounds per second, and you only have 500 rounds on board. Winning a dogfight with guns these days is one of the most demanding things a pilot can do.

TRAINING MISSION 2

Now it's time for a one-on-one dogfight. After splashing the C-130 a few times, replace the cargo plane targets with a single opponent. From the startup screen, choose DOGFIGHT, 1, a fighter type (probably either a MiG-21 or Mirage 2000 to start with), and any altitude.

If you're looking for an easy start, give yourself a pair of AMRAAMs or maybe Sidewinder -Ms instead of -Js on your light hardpoints in addition to your wingtip Sidewinders.

Put yourself in a head-to-head engagement and blow him up, if you can. Try not to give up too much speed or altitude as you execute some basic maneuvers. Maintain an optimal maneuverability speed of 450 knots indicated airspeed. If you can hold that speed *at all times* while maneuvering offensively and defensively, you will probably get him. The F-16 has one of the best thrust to weight ratios of any plane in the world. Use it! You can fly straight up if you need to. You can turn with and inside of any aircraft in the world. Look at the aircraft stats in the back of this book and be very aware of which aircraft you can run away from. The F-16 is one of the best dogfighters in the world, but the top speed isn't that hot. An F-15, Su-27 or even a MiG-21 can chase you down without too much trouble.

TRAINING MISSION 3

In this mission, you familiarize yourself with basic ground attack techniques against various targets.

Choose SEARCH-AND-DESTROY from the training mission screen. When you are given the opportunity to load your plane, choose a full load (4) of rocket pods on your medium hardpoints and a full load (12) of Mk82s on your heavy hardpoints.

When you start out, bring up your nav map, select Halverston, and autopilot there. Make a quick pass over the city, looking for a skyscraper to level. When you've selected a likely target, head out about 6 to 8 nautical miles, turn around, adjust your altitude to between 1000 and 2000 feet, and head for your target. Try setting your weapons to Mk82 in CCIP mode at first, to practice precision bombing.

As you approach, you should be in a shallow dive — about 10 degrees. Keep your speed moderate, (about 400 knots true) and use your rudder to make final course corrections as you approach your target. Let the pipper line up on your target, watch for the In Range indicator to light and pull the trigger — once. If your weapon camera is turned on, you can watch the bombs drop toward the target and (possibly) a direct hit.

If you miss, turn around and repeat the process. To practice lining up targets, you can drop each of your bombs on a different building.

Next, it's time for some tougher practice, using rockets. Autopilot to "The Slot" and fly the canyon. If you see enemy fire, hunt down the source and remove it before it removes you. To use rockets on a target, line up using the rudder, as before, and wait for the In Range indicator to light. When it's lit and your rocket sight is on the base of the target, let 'em fly. With practice, you'll be a menace to any ground target. And you have plenty of rockets to practice with, so don't worry about wasting ammo now.

When you reach the mesa in the center of the canyon, climb to pick off some targets around the runway located there. In later training missions, you can load up with Durandals and practice bombing the runway, too.

For a more challenging mission, take the same loadout and try the Caldera. The AA defenses are a bit more intense there, so you'll have to be at your best to fly it safely.

When you've dropped all your bombs, you can try practice landings at the Strike base. Autopilot there and try a landing by the book. (see **Landing**, p. 69) The key to landing, as with all aspects of jockeying an F-16, is practice.

TRAINING MISSION 4

In this mission, you practice dogfighting in a one against two formation. You will be handicapped, loaded with both air-to-air and air-to-ground weapons.

This time, select two enemies in a single group. Start with MiG-21s or Mirages at first, and work your way up to MiG-29s, Su-27s, or other F-16s. To practice with your plane weighted down, pick your normal wingtip missiles, Sidewinders or AMRAAMs on the light hardpoints, and a stack of Mk20s or Mk82s on the medium and heavy hardpoints. If that's just too much weight, try Mavericks, or maybe just a pair of GBU-15s on each set of hardpoints. Once you're loaded (and this is as heavy as it gets), get on the runway to fight your two much more maneuverable opponents.

It's good to practice fighting against numerically superior enemies because you are about to enter a world in which such situations are the norm. In multiple plane furballs, you have to make kills quickly, or be killed. Your most valuable weapons, AMRAAM missiles, should be launched one per target, before you make visual contact. Target the planes with the highest closure rates first, since those guys will be down your throat in a hurry.

Standard military doctrine says that if you are bounced on the way to a ground strike, you are supposed to jettison the bombs so you can maneuver, then engage the air enemy if you think you can win, or disengage and run if you are outmatched. The Wildcats operate under a very different set of rules. The ordnance you are carrying is valuable and you can't complete a given mission without it. If you want to fly for the Wildcats, you have to be able to fight your way through the opposition to reach your target, hit it, and get home in one piece, maximizing kills made with cheap weapons.

Breaking Missile Lock

After you have the head-to-head attack down, let the enemy get behind you. This situation should result in an almost immediate missile lock on your aircraft. Don't panic. This is practice. Practice breaking missile locks by cutting the afterburner and dropping flares, then bank sharply. Dropping flares will not usually be enough to distract a modern IR homing missile. You have to radically change your IR signature and maneuver. Breaking radar homing missile locks is a similar procedure, except that they are usually fired from longer ranges and from the front in the initial phase of the engagement. The tactics are the same: Drop decoys and turn at the last moment. Just bear in mind that the AMRAAM and the radar guided SAMs are much faster than the IR homing Sidewinders.

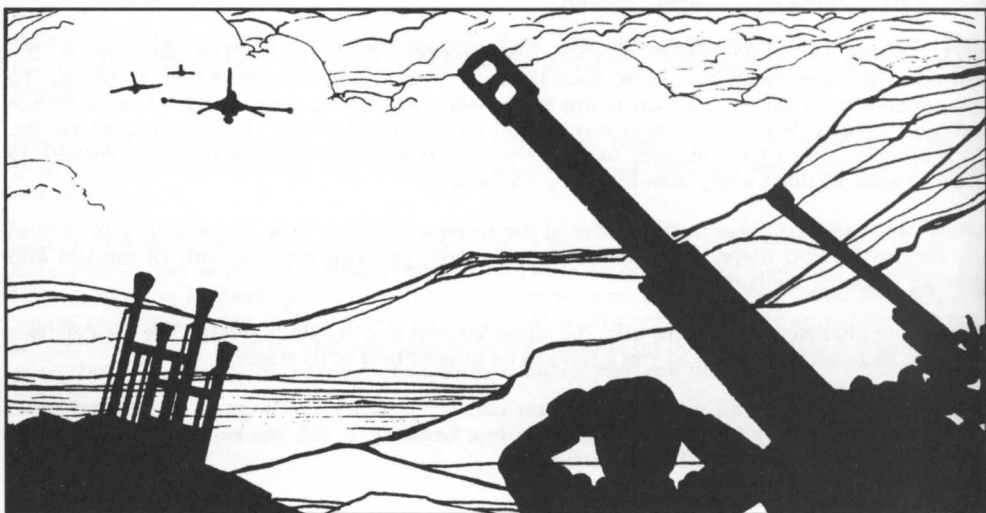

REFERENCE

WEAPONS

Range. The weapon's range in nautical miles. In some cases, the range of the weapon will depend on the altitude and velocity of the launch platform. In other cases, the lock range (the range at which the weapon can acquire a valid target) will be less than the true range of the weapon. Both exceptions are noted in the description.

HUD Mode. The mode displayed in the lower left corner of the HUD, under the airspeed tape. If the weapon can be used in more than one mode, they will be separated by a slash.

Guidance. The type of guidance system the weapon uses.

Cost. The cost of the weapon, in dollars, to the Wildcats.

AIM-9J

Range6 nm
HUD ModeSRM
GuidanceIR homing
Cost\$30,000

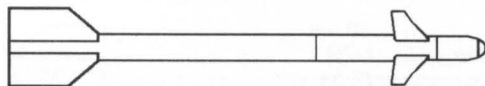

The AIM-9J is an antique. It is a testament to the very solid design of the Sidewinder series that it is still in service at all. The seeker head is of an old type and is quite prone to countermeasure distraction (flares). These missiles have even been known to veer into the sun every now and then. This seeker is not sensitive enough to lock onto a target from the front; the weapon must see the rear aspect (hot tailpipe) in order to acquire the target. It does have some hidden advantages, though. The warhead is detonated by a proximity sensor (like most AAMs), but the fuse is as antique as the missile, and usually functions only after the missile is inside the target. This means that while the -9J will sometimes miss its target, when it hits the results are catastrophic. It is also very cheap, as AAMs go.

AIM-120 AMRAAM

Range40 nm
HUD ModeMRM
GuidanceSemi-active
 radar homing
Cost\$200,000

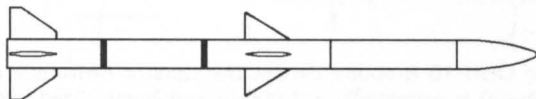

The AIM-120 Advanced Medium Range Air-to-Air Missile is the current last word in BVR (beyond visual range) weaponry. It is a terminally active radar homer with inertial guidance up to the activation point, and is capable of receiving mid course updates. What that means is the missile is launched in the direction of a bogey (usually at a radar blip), maintains its heading with very precise gyros and fast microprocessors, and at a set point turns on its internal radar and hunts the target on its own. Any time during the flight, the firing platform may transmit a new heading to the missile by radio and the missile will go off in another direction. The mid-course updating process is usually carried out by computer. The weapon travels at a peak velocity of Mach 4.2. The warhead is detonated by a very fast and reliable laser proximity fuse. The only bad thing about the weapon is that it can't turn very well, limiting its use in dogfights. But, like they say, long distance is the next best thing to being there.

AGM-65D Maverick

Range13 nm
HUD ModeIR
GuidanceImaging infrared
Cost\$100,000

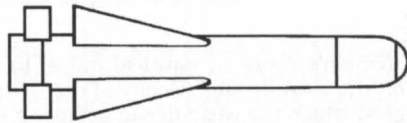

The Maverick is a true fire-and-forget weapon. You just show it the target and turn it loose, and it homes in on the image of the target stored by the missile seeker head. In order to get a positive lock on a target, the missile must be able to "see" the target. Visual conditions being what they are on the battlefield, you will rarely be able to see a target beyond three miles. The warhead is heavy enough to destroy any known ground vehicle, and will damage small ships.

AIM-9M

Range10 nm
HUD ModeSRM
GuidanceIR homing
Cost\$60,000

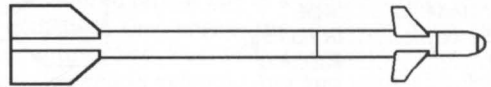

The -9M is a vastly improved Sidewinder. The seeker is less prone to distraction, and can engage targets in all aspects. The warhead is twice as large, the fusing mechanism actually works, and it goes faster and farther than the -9J. It also maneuvers a little better. The improvements do not come without a price tag, and this missile is twice as expensive as its older brother.

GBU-15(V)/B Smart Bomb

Range4 nm
HUD ModeIR
GuidanceImaging infrared
Cost\$100,000

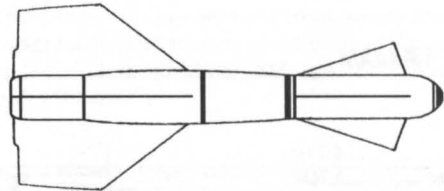

The GBU-15 (nobody except the master ordnance chief uses the full designation of this weapon) is essentially a 2,000-pound bomb fitted with a Maverick-like guidance sensor and two sets of fins for lift and aerodynamic control. It is a bomb that homes like a Maverick. Most pilots use the -15 to destroy big, important targets, like bridges and buildings. You can't carry very many of them, so pick your targets carefully.

Mk82 General Purpose Bomb

RangeN/A
HUD ModeCCIP/CCRP
GuidanceNone
Cost\$10,000

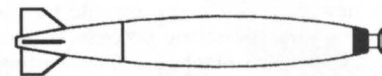

The Mk. 82 is the simplest air-to-ground weapon in the Wildcats' arsenal. The simpler a weapon is, the more complex the delivery system and the more trained the pilot must be. The Mk. 82 is no exception. They are very cheap compared to the other weapons. If you can fly well enough to use iron bombs effectively, you will increase your profit margin considerably.

LAU-3 Rocket Pod

Range2 nm
HUD ModeSTRF
GuidanceNone
Cost\$10,000

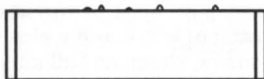

The LAU-3 represents one of the most common air-launched weapons in service today: the unguided fin stabilized rocket. Its warhead is small, and most target vehicles can take one or two near misses, but these weapons are launched in salvos. Two pods with nineteen rockets each will put 38 weapons in and around the target in a matter of seconds. The F-16 can carry up to eight pods and can fire them all at once. As an added bonus, they can be fired at planes if the target aircraft will hold still long enough to be hit.

Mk20 Rockeye Cluster Bomb

RangeN/A
HUD ModeCCIP/CCRP
GuidanceNone
Cost\$20,000

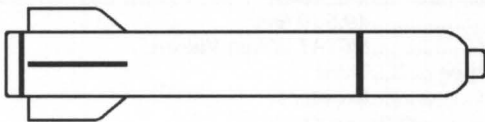

The Rockeye is a shell containing 247 pound-and-a-half bombs. These are dispersed (when the weapon bursts at a preset distance above the ground) to cover about a 200 feet by 250 feet area (around 50,000 square feet). The bombs detonate on impact. Rockeye bomblet detonation is strong enough to kill most soft skinned vehicles, and a direct hit is enough to kill a tank if it gets the engine deck.

Durandal Runway Cratering Munition

RangeN/A
HUD ModeCCRP
GuidanceNone
Cost\$30,000

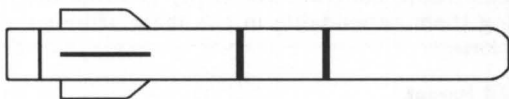

Durandal is designed specifically to destroy runways, taxi areas and hardened aircraft shelters. At weapon release, the Durandal deploys a braking parachute and tips nose down. After a time delay, a rocket motor blasts the weapon into the ground, where it explodes. Durandal can penetrate around 16 inches of concrete or asphalt ground cover before the fuse functions. The detonation creates an underground "pocket" crater that is tough to repair. The blast radius of the weapon is very small since the force is contained by the ground, so you have to be dead on target to use Durandal effectively.

PLANE SPECIFICATIONS

- Engines.** The number of engines the plane has. Unless noted otherwise, assume jet engines.
Max Range. Operational range (one way) of the aircraft in nautical miles on internal fuel assuming a constant throttle of MIL 4 and a clean plane.
VmaxHi. Maximum speed in knots, clean, on full afterburner at 36,000 ft.
VmaxLo. Max speed clean in knots, full afterburner at sea level.
Ceiling. The maximum altitude in feet the plane can reach in stable flight.
Loadout. The standard gun loadout on the plane.
Fighter type. A rough estimation of how advanced the fighter is, based as much on the sophistication of its radar as on any other criterion. First generation is oldest; Third is most advanced.
Maneuw. A general agility rating based on turn radius, roll rate, wing drag and rate of climb.

F-16 Fighting Falcon

Engines.....1
Max Range.....905 nm
VmaxHi.....1158 knots
VmaxLo.....791 knots
Ceiling.....49,530 feet
Loadout.....M61A1 20mm Vulcan
Fighter typeThird
Maneuw.Excellent

The F-16 is the plane you must master and is one of the most versatile and maneuverable planes in the world today. It is a "fly by wire" plane; the ailerons and other moving surfaces are activated via electrical impulse rather than by bulky hydraulic actuators. The electrical signals from the pilot's controls are fed into a computer which determines the best way to move the control surfaces to achieve the result the pilot asked for. It sounds cumbersome, but the fly-by-wire system was a quantum leap in aircraft control technology. The electronic controls are triply redundant, making them dependable in the most arduous conditions.

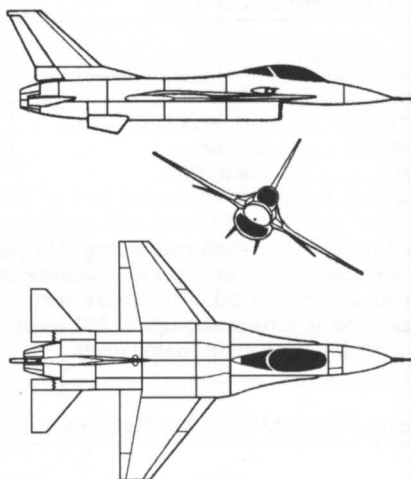

F/A-18 Hornet

Engines.....2
Max Range.....950 nm
VmaxHi.....1032 knots
VmaxLo.....795 knots
Ceiling.....50,400 ft.
Loadout.....M61A1 20mm Vulcan
Fighter typeThird
Maneuw.Good to very good

The Hornet was designed to be a jack-of-all-trades aircraft. Unfortunately, that made it master of none. It has a very good radar and can carry a great deal of ordnance, is very maneuverable, has a great roll rate, but is a mediocre dogfighter due to the weak engines.

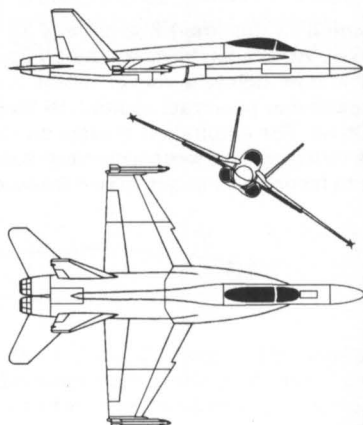

F-15 Eagle

Engines.....2
Max Range.....1881 nm
VmaxHi.....1338 knots
VmaxLo.....810 knots
Ceiling.....64,350 ft.
Loadout.....M61A1 20mm Vulcan
Fighter typeThird
Maneuw.....Very good

The F-15 was designed to counter what was supposed to be a Russian superfighter: the MiG-25 Foxbat. When it was discovered that the Foxbat was a dedicated interceptor and not an air superiority fighter at all, the F-15 was left as the premier fighter aircraft in the world. It has impressive top speed and turning ability for a large fighter. Be very careful when engaging this plane.

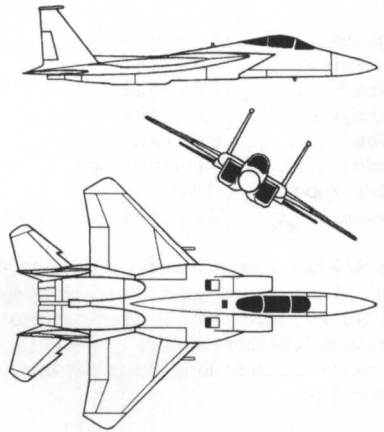

MiG-21 Fishbed

Engines.....1
Max Range.....531 nm
VmaxHi.....1204 knots
VmaxLo.....540 knots
Ceiling.....60,125 ft.
Loadout.....GSh-23 23mm cannon
Fighter typeFirst
Maneuw.....Good

The MiG-21 is an antique in the 21st century, but its low price and the huge numbers produced during the cold war will keep it in service for some time to come. In most air forces, it serves as a ground attack aircraft, but in poorer countries and squadrons it performs intercept and CAP missions as well.

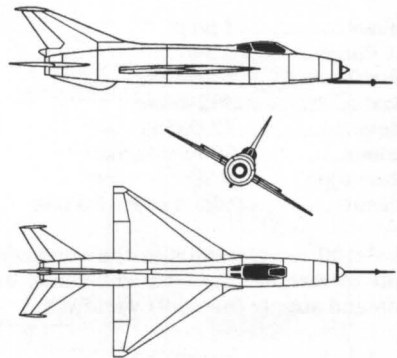

MiG-29 Fulcrum

Engines.....2
Max Range.....806 nm
VmaxHi.....1260 knots
VmaxLo.....700 knots
Ceiling.....59,800 ft.
Loadout.....30 mm cannon
Fighter typeThird
Maneuw.....Very good to excellent

The Fulcrum is a good match for the F-16, and indeed, both planes were designed for the same general mission: short range air intercept and ground attack missions. The MiG-29 is marginally more survivable due to the twin engine design.

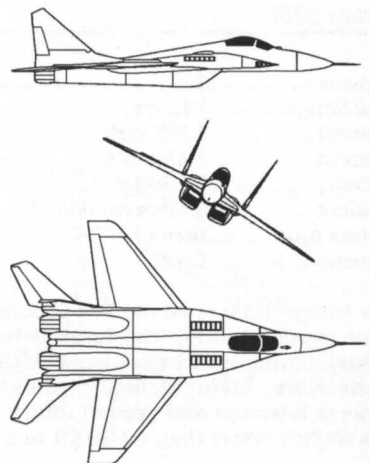

Su-27 Flanker

Engines.....2
Max Range.....1000 nm
VmaxHi.....1320 knots
VmaxLo.....725 knots
Ceiling.....49,530 ft.
Loadout.....30 mm cannon
Fighter typeThird
Maneuw.....Very good to excellent

The Sukhoi design bureau had a long history of solid aircraft design when they produced the Su-27, and the *Flanker* maintains that standard. It is most similar to the F-15, and has the same mission: long range air intercept and superiority.

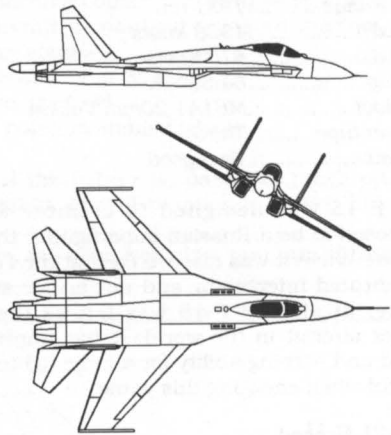

C-130 Hercules

Engines.....4 prop
Max Range.....3,240 nm
VmaxHi.....332 knots
VmaxLo.....332 knots
Ceiling.....32,695 ft.
Loadout.....30 mm cannon
Fighter typeN/A
Maneuw.....Like a pregnant yak

The C-130 is ubiquitous in the shadowy world of the mercenary pilot. It is commonly used for troop and supply transport worldwide.

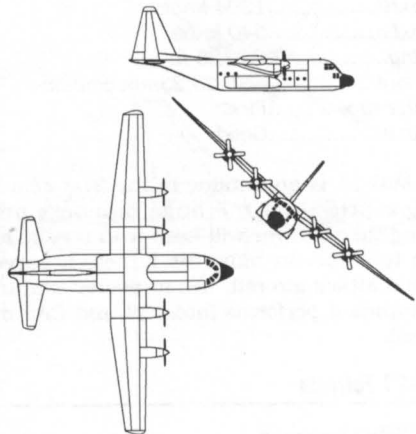

Mirage 2000

Engines.....1
Max Range.....741 nm
VmaxHi.....1262 knots
VmaxLo.....800 knots
Ceiling.....58,500 ft.
Loadout.....30 mm cannon (2)
Fighter typeSecond
Maneuw.....Good

The *Mirage 2000* is an old but popular French-built export fighter. The large delta wing is lightly loaded, and produces high drag in maneuvers, losing velocity quickly. It can perform intercept and ground attack missions. It is slightly better than a MiG-21 in a dogfight.

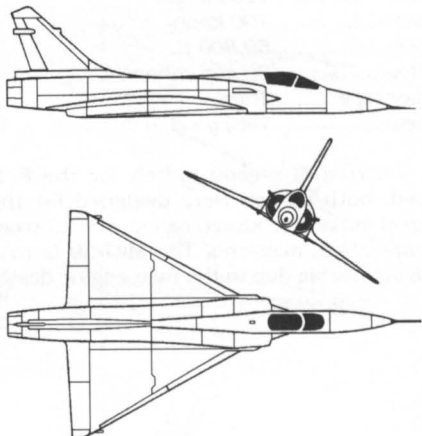

A-10 Thunderbolt II

Engines.....2
Max Range.....1189 nm
VmaxHi.....381 knots
VmaxLo.....381 knots
Ceiling.....44,525 ft.
Loadout.....30 mm DPU
Fighter typeSecond
Maneuw.....Very good

The *Warthog* (as its pilots call it) is a dedicated ground attack aircraft. The *Warthog's* natural prey are main battle tanks, and it carries the most powerful cannon of any aircraft flying: the GAU-8A Avenger seven-barreled 30mm, firing depleted uranium slugs. The gun was meant for ground targets, but all *Warthog* pilots dream of the day when they can zap an overconfident fighter jock.

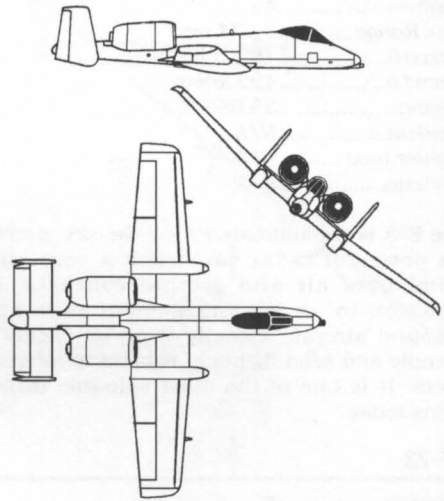

Tornado

Engines.....2
Max Range.....1691 nm
VmaxHi.....1262 knots
VmaxLo.....792 knots
Ceiling.....69,338 ft.
Loadout.....27 mm cannon (2)
Plane type.....Second
Maneuw.....Fair

The *Tornado* was a joint British, German and Italian design project completed in the mid '80s. The idea was to create a jet which could be configured as a ground attack plane or as an air superiority platform. They came very close to doing it. The *Tornado* presented here is the fighter version. If this excellent plane has a weakness, it is the slow top speed.

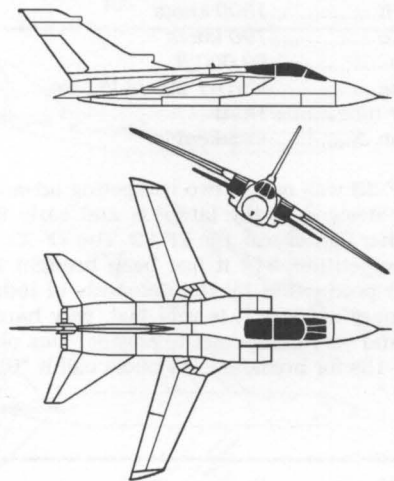

Lear Jet

Engines.....2
Max Range.....1080 nm
VmaxHi.....400 knots
VmaxLo.....400 knots
Ceiling.....37,375 ft.
Loadout.....N/A
Fighter typeN/A
Maneuw.....Good

The Lear is the transport of choice for the status-conscious executive in the 21st century.

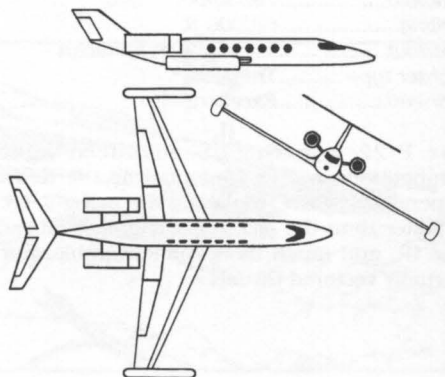

E-3 Sentry "AWACS"

Engines.....4
Max Range.....4,374 nm
VmaxHi.....460 knots
VmaxLo.....422 knots
Ceiling.....39,650 ft.
Loadout.....N/A
Fighter typeN/A
Maneuw.....Poor

The E-3 is the ultimate eye-in-the-sky aircraft. Its powerful radar can track a very large number of air and ground contacts. Its function in an air engagement is to spot inbound aircraft, classify them as enemy or friendly and send flights of fighters to intercept them. It is one of the most valuable targets flying today.

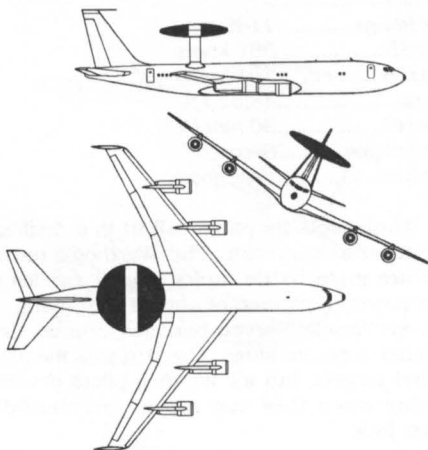

YF-23

Engines.....2
Max Range.....1,296 nm
VmaxHi.....1300 knots
VmaxLo.....790 knots
Ceiling.....60,000 ft.
Loadout.....M61A1 20mm Vulcan
Fighter typeThird
Maneuw.....Excellent

The YF-23 was one of two competing advanced fighter designs in the late 80s and early 90s. The other fighter was the YF-22. The YF-23 lost the competition, but it has been brought into limited production by the demands of today's mercenary market. It is very fast, very hard to spot, and very dangerous to engage. This plane eats F-15s for breakfast. Its pilots call it "Black Widow."

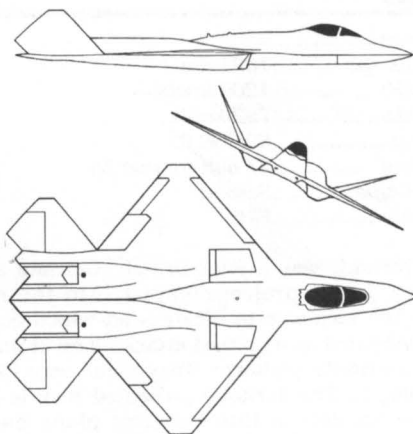

F-22

Engines.....2
Max Range.....1,300 nm
VmaxHi.....1330 knots
VmaxLo.....795 knots
Ceiling.....60,000 ft.
Loadout.....M61A1 20mm Vulcan
Fighter typeThird
Maneuw.....Excellent

The F-22 won the US advanced fighter competition, and was adopted as the new air superiority fighter, replacing the aging F-15. It is faster than the -15, harder to spot on radar and IR, and much more maneuverable due to partially vectored thrust.

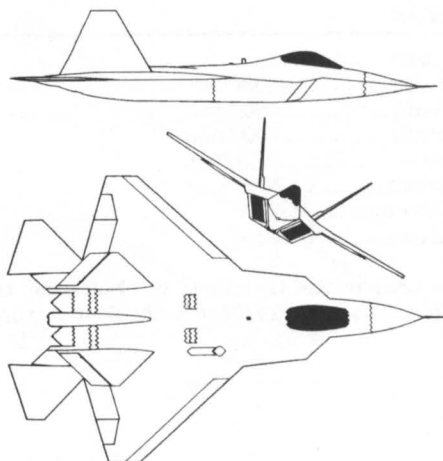

TU-20

Engines.....4 Prop
Max Range.....8,000 nm
VmaxHi.....500 knots
VmaxLo.....410 knots
Ceiling.....40,625 ft.
Loadout.....N/A
Fighter typeFirst
Maneuw.....Poor

The Tu-20 (military designation: Tu-95 Bear D) was the pinnacle of prop-driven intercontinental bomber technology during the 1950s. It survives today as an export plane in the air forces of some of the more well-off third world countries and larger corporations. Bear's specialty used to be delivering free fall nuclear bombs, but it can still cause a great deal of damage with plenty of 500 pounders.

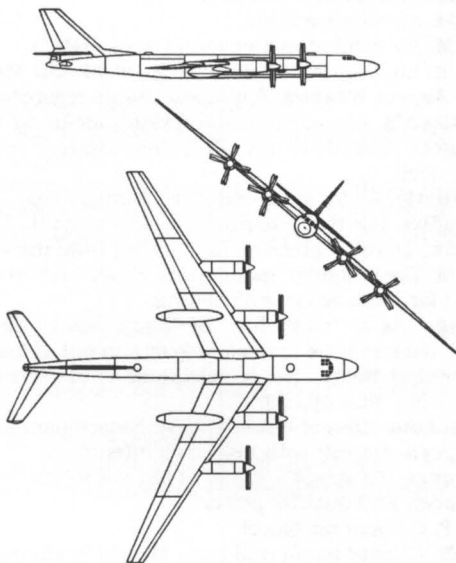

747 Jumbo Jet

Engines.....4
Max Range.....4,374 nm
VmaxHi.....400 knots
VmaxLo.....400 knots
Ceiling.....37,650 ft.
Loadout.....N/A
Fighter typeN/A
Maneuw.....Poor

The 747 is used by a long list of civilian airlines and several corporations. It is even more of a sitting duck than the E-3, since it has only a short range radar to warn of incoming threats. It has none of the sophisticated electronic countermeasures or decoy systems of a military plane.

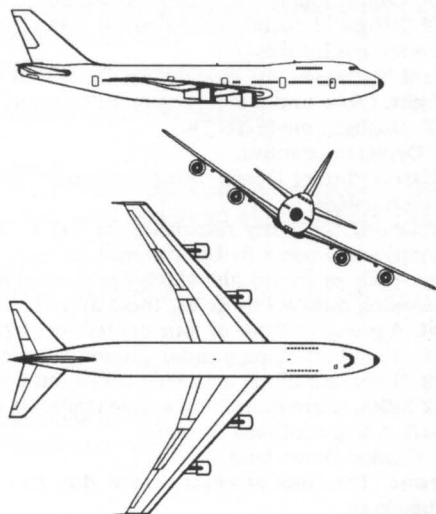

GLOSSARY

- AAM.** Anti-aircraft artillery.
- AAM.** Air-to-air missile.
- ACM.** Air combat maneuvering mode (HUD).
- AGM.** Air-to-ground missile (e.g., AGM-65D Maverick).
- All Aspect Weapon.** A weapon usable regardless of the target's facing (aspect).
- AMRAAM.** Advanced medium range air-to-air missile.
- Angels.** Altitude of aircraft in thousands of feet. Example: Angels 29 is twenty-nine thousand feet.
- Ballistic.** As in "going ballistic." Straight up.
- Bandits.** Positively identified enemy aircraft.
- Bank.** To roll a plane so that the lift from the wings is no longer away from the ground.
- BFM.** Basic fighter maneuvers. Basic one-on-one fighter tactics used as the building blocks for more advanced training.
- Bingo.** As in "bingo fuel" or "bingo point." The point in the mission when a plane has to go back to base *immediately* or run out of fuel.
- Bitching Betty.** The female voice of the terrain collision warning system on the F-16 ("Pull up... Pull up...").
- Blackout.** Loss of vision and/or consciousness due to positive Gs.
- Bogeys.** Aircraft with unknown intentions.
- Bounce.** To attack a group of aircraft intent on something else.
- Buster.** Full military power.
- CAP.** Combat air patrol.
- CBU.** Cluster bomb unit (e.g., Mk. 20 Rockeye).
- CCIP.** Continuously computed impact point (HUD mode).
- CCRP.** Continuously computed release point (HUD mode).
- Chaff.** Strips of metal-coated mylar jettisoned from a plane by the thousands to confuse radar-guided missiles.
- Control Surfaces.** The movable surfaces that control a plane's maneuvering.
- Dogfight.** Close and fast engagement between enemy aircraft.
- DGFT.** Dogfight mode (HUD).
- DPU.** Depleted uranium.
- EL.** Extraordinary losses. Most mercenary contracts include an EL clause to hedge against such losses.
- Electric Jet.** An early nickname for the F-16, since it has been the only production jet in America to use a fly-by-wire system exclusively.
- Flares.** Pods of chemicals which are ejected and ignited just behind the plane to decoy heat seeking missiles by giving them an alternative bright source to home on.
- Flight.** A group of three or four fighters configured for the same mission.
- Fox 1.** "I am launching a radar-guided missile."
- Fox 2.** "I am launching a Sidewinder-J missile."
- Fox 2 Mike.** "I am launching a Sidewinder-M missile."
- Furball.** A big, confused dogfight.
- GBU.** Guided Bomb Unit.
- Grayout.** The loss of color vision due to excessive positive Gs immediately proceeding blackout.
- Hard Deck.** A particular altitude band that you must not cross for some reason. Example: "There's a hard deck at Angels 10, ladies. Anything below that is fair game for the AAA boys."
- Hill Disease.** The result of piloting your airplane into the ground (as in "He caught hill disease last week").
- HUD.** Heads-up display.
- IFF.** Identification friend or foe. Allows you to tell the friendly aircraft from the non-friendly ones from beyond visual range. All planes operating on the same side of a dispute will have a radio transponder keyed to a certain frequency. When you radar-designate an air target, your radio sends out a coded pulse to the target. If it gets the proper reply from the target's computer, you know the target is friendly, and an "x" is drawn through the target box.
- Illuminate.** Transmit radar signals towards a target.
- IN RNG.** In range indicator (HUD).

IR. Infrared.

I-R. Infrared mode (HUD).

Jock. A fighter pilot (as in "fighter jock").

Jump. Attack another group of planes.

Knot. One nautical mile per hour.

Lock. See *Missile Lock*.

Mach. Mach 1 is the speed of sound. Mach 2 is twice the speed, and so forth.

Missile Lock. When the seeker head of a missile has acquired a target. Often accompanied by an aural cue in the cockpit (the "tone"). See also *Tone*.

MFD. Multi-function display. MFDs replace the bewildering array of analog gauges which characterized the fighter cockpits of the past with one or two video displays with multiple modes. Now pilots have a bewildering array of switches to flick to change modes on each screen.

MNC. Multi-national corporation.

MRM. Medium range missile.

Nautical Mile. 2000 yards, or 1.14 miles.

NM. Nautical mile.

Package. A group of planes with different weapons loadouts but the same general objective.

Pickle. To release freefall air-to-ground ordnance.

Pipper. The center dot in the Vulcan's sight reticle, used in dogfighting.

Pitch. pointing the nose of the aircraft up or down, relative to the plane of the wings.

Punch Off. To jettison all non-AAM stores in order to increase maneuverability in preparation for a dogfight.

Punch Out. To eject.

Raid. Air raid.

RAW. Radar warning receiver. Also known as a threat warning indicator (TWI).

Rear-Aspect Weapon. An air-to-air missile that can only lock on the rear (exhaust) of a target.

Redout. Loss of vision and/or consciousness due to negative Gs.

Reticle. The central part of a weapon sight (sighting display) on the HUD.

Roll. Rotation of the aircraft around its long axis.

Rotation. The point during takeoff when the nosewheel leaves the tarmac.

SAM. Surface-to-air missile.

Seeker Head. The part of a missile that tracks targets.

Situational Awareness. The intuitive understanding, honed by training, of where in the sky he is relative to everything else in the air. The most important skill a fighter jock can cultivate.

Six. The six o'clock position (directly behind you).

Speed Brakes. Also called air brakes, these create massive drag on the aircraft to slow it down quickly.

Splash. To shoot down.

Spoof. To confuse the guidance head of an incoming missile so badly that it misses.

Squawk Box. The IFF transponder.

SRM. Short range missile; also short range missile mode (HUD).

Stall. When a plane exceeds its critical angle of attack and loses lift.

Starship. Fighter pilot slang for the F-15.

STRF. Strafe mode (HUD).

STT. Single target tracking mode (on air-to-air radar MFD).

TDF. Turkish Diplomatic Forces.

Tone. The aural lock-on cue of a missile seeker head (as in "I've got tone...").

TWI. Threat warning indicator.

Vampire. Incoming air-to-ground missile.

Warthog. Pilot slang for the A-10.

Waterline. The horizon line on the air radar display. So named for the W-like character in the middle.

Grayout. The loss of color vision which is the first sign of positive G blackout.

Yaw. Turning the plane left or right using the rudder.

INDEX

Entries in small caps indicate selection buttons on option screens

- 360° LOCK
 COCKPIT.....50
- 360° RADAR
 COCKPIT.....50
- 747.....87
- A**
- A-10.....85
- ABORT
 EXIT GAME.....48
- ACCEPT (training missions).....47
- ACE
 CONFIGURATION.....48
 dogfight training mission.....47
 GAMEPLAY/ENEMY INTELLIGENCE.....49
- ACM mode.....60
- Afterburner.....59,67,68,69,
 74,78,82
- AGM-65D.....53,61,62,74
- AIM-9J.....see missiles
 (short range)
- AIM-9M.....see missiles
 (short range)
- AIM-120.....53,62,73,74,
 75,77,78,79
- Air-to-ground radar MFD.....64
- Airspeed
 calibrated.....58,59
 HUD.....58,59
 tape.....58,59
 true.....58,59
- ALTITUDE
 above terrain.....58,59
 dogfight training mission.....47
 tape (HUD).....58,59
- AMRAAM.....see AIM-120
- AUDIO
 CONFIGURATION.....50
- Auto-landing.....69
- Auto-save.....46
- AUTO-SWITCHING.....50
- CAMERAS.....49
- Auto takeoff.....68
- Auto target tracking.....51
- AUTO TARGETING
 COCKPIT.....50
- Autopilot.....67,77
- AWACS.....see E-3
- B**
- Back cockpit camera.....51
- BACKUP (training missions).....47
- Bank.....69
- Bar (Selim's).....57
- Barracks.....46,52,54
- Baseline.....see Richards
- Basic fighter maneuvers.....70
- Bear.....see Tu-20
- Beetlebaum, Virgil.....6,12,17,18,
 52,54-55
 office.....see office
- Begin mission.....see cockpit
- Billy.....see Parker
- Black Widow.....see YF-23
- Blackout.....67
- Brakes.....66,67,68,69
 BRAKES (brakes on).....58,59
- Break.....71,72
- Briefing.....52,53,56
- Buying weapons.....see catalog
- C**
- C-130.....18,52,76,84
- Calculator.....55
- Caldera.....77
- Camera views.....50-51,67
- CAMERAS
 CONFIGURATION.....49
- CANCEL
 loading games.....54
 Training Mission.....47
- Cannon.....see Vulcan
- Catalog.....52,53,54-55,56
- CCIP.....see continuously
 computed impact point
- CCRP.....see continuously
 computed release point
- Chaff.....63,74,75
- Chase camera.....51,69
- CITIES
 DETAIL/TERRAIN.....49
- Clayton.....see Travis
- Climb.....68,71,73
- Closure rate.....72
 HUD.....60
- Cockpit.....47,53
 CONFIGURATION.....50
 camera.....51
 Damage MFD.....63
 instruments.....58-65
- Combat geometry.....70
- Communications MFD.....58,63-64
- CONFIGURATION.....see option screens
- CONTINUE
 EXIT GAME.....48
- CONTINUE GAME.....46
- Continuously computed
 impact point.....60,62,75,77
- Continuously computed
 release point.....60,62,75,77
- CONTROL
 FLIGHT.....49
- Credit.....55
- Cross hairs
 gun camera.....51,63
 IR.....60,62
- Current heading.....59
- D**
- Damage
 and camera views.....50
 MFD.....63,68,69
- DEFAULT
 CONFIGURATION.....48
- Deflection.....70-71,72,74
- DELETE (saved game).....54
- DETAIL
 CONFIGURATION.....48-49
- DGFT mode
 and gun camera.....51,63
- Diamond
 SRM (HUD).....60,61
 TWI.....65
- DIGITAL FX
 AUDIO.....50
- Direction tape.....58
- Distance to waypoint.....58,59
- Dive.....68,71
- Dogfight
 maneuvers.....71
 mode.....61
 sight reticle.....60,77
 TRAINING MISSION.....47,77
- Drag.....66
- Durandal.....53,61,75,77,81
- E**
- E-3.....76,86,87
- Eagle.....see F-15
- EASY GUN HITS
 GAMEPLAY.....49
- EASY LANDINGS
 FLIGHT.....49
- Empty bed.....54
- ENEMY INTELLIGENCE
 GAMEPLAY.....49
- ENOUGH (dogfight
 training mission).....47,76
- EXIT
 CONFIGURATION.....48
 EXIT GAME.....48
 game (barracks or tent).....46
- EXIT GAME
 CONFIGURATION.....48
- External camera.....51,71
- F**
- F-15.....77,83,84,86
- F-16.....52,77,78,82,83
- F-22.....86
- F/A-18.....82
- FAR
 DETAIL/HAZING.....49
- FIELDS
 DETAIL/TERRAIN.....49

- Fighter plane
 hangar.....52
 Strike base56
- Fishbedsee MiG-21
- Fixers4,57
- Flankersee Su-27
- Flaps.....63,67,68
 FLAPS (flaps down).....58,59
- Flares.....63,73,78,79
- FLIGHT
 CONFIGURATION49,68
- Flying missions47,53
- Forrester, Gwen "Phoenix"....8-9,14,
 17,18,20,21
- Four-G pull-up warning (HUD) ...59
- Friendly targetsee target
- Fuel67
 remaining (Damage MFD)63
 warning (HUD).....59
- Fulcrumsee MiG-29
- G**
 GBU-1553,61,62,74,75,78,80
- Gs67,76
 Current (HUD)58,59
 Max (HUD).....58,59
 pull-up warning.....59
- G EFFECTS**
 COCKPIT.....50
- GAMEPLAY**
 CONFIGURATION49
- Gear.....66,69
 Damage MFD.....63
 GEAR (gear down)58,59
- Generation65,82-87
- Geometry (combat).....70
- GOURAUD**
 DETAIL/TERRAIN49
 DETAIL/OBJECTS49
- Gravity.....66
- Grayout67
- Guillaume, Claude.....18
- Gun camera51,63
- Gwensee Forrester
- H**
 Halverston77
- Hand (fixer's).....57
- Hangar doorway.....47,52
- Hardpoints.....53
- HAZING**
 DETAIL.....49
- Heading59
 current (HUD).....58,59
- Hercules.....see C-130
- HI-LO**
 DETAIL/OBJECTS49
- High yo-yo72
- HUD58-62,69
 and camera views50
- I**
 Immelmann71,73
- In range (HUD)60,61,74,77
- Infrared mode62
- Install Guide.....46,48
- INTEREST**
 DETAIL/TERRAIN49
- IR**
 cross hairs.....60
 lock warning.....58,65,78
 missiles.....see missiles,
 AIM-120 and Maverick
- IRS**.....5,33,42
- J**
 Jackals5,36-38,39
- Jamessee Stern
- Janetsee Page
- Jeep46,52
- JOYSTICK**
 FLIGHT/CONTROL.....49
 FLIGHT/PANNING CONTROL.....49
- Jumbo jetsee 747
- K**
 Keyboard68
 FLIGHT/CONTROL.....49
 FLIGHT/PANNING CONTROL.....49
- Kill board52,54-55,56
- L**
LADDER
 COCKPIT.....50
- Lag pursuit70,71
- Lag roll71,72
- Landing69,77
 auto-landing.....69
- Landing gearsee gear
- LAU-353,61,81
- Lead pursuit70
- Lear jet76,85
- Ledger52,53,54-55,56
- Left cockpit camera.....51
- Lift.....66
- LOAD (saved game).....46,54,56
- LOAD GAME46,52,53
- Loading weapons.....47,53,56
- Loadout53
- Loop71
- Low yo-yo.....72
- Lylesee Richards
- M**
 M61A1see Vulcan
- Mach (HUD)58,59
- Main room (Selim's)57
- Mapsee nav map
- Maverick.....53,61,62,74,75,78,80
- Maxima.....12
 Gold Card17-18,19,21
- MEDIUM**
 CAMERAS/WINDOW SIZE49
- Mercenary Defense
 License Application46
- MID-AIR COLLISIONS**
 FLIGHT49
- MiG-2177,78,83,84
- MiG-2978,83
- Miguel.....see Schraeder
- Military power59,68
- Mirage 2000.....77,78,84
- Missiles (short range).....61-62,73,
 74,76,77,78,79,80
 see also AIM-120 and Maverick
- Missions**
 getting missions57
 training.....see training missions
- Mk2053,61,78,81
- Mk8253,61,77,78,80
- MORE (dogfight training mission) .47
- Mouse.....68
 FLIGHT/CONTROL.....49
 FLIGHT/PANNING CONTROL.....49
- Multi-function displays63-64
- Multi-National Corporations.....42
- Multiple target tracking mode64
- MUSIC**
 AUDIO50
- N**
 Nav map.....52,59,67
- NEAR**
 DETAIL/HAZING49
- NEW (saved game)54
- NONE**
 FLIGHT/PANNING CONTROL.....49
- O**
 Object viewersee VIEW OBJECTS
- OBJECTS**
 DETAIL.....49
 Office52
- Strike base.....56
- Opponents (dogfight training mission).....47
- Opposition break71
- Option screens.....48-50,67
- OVERWRITE (saved game)54
- P**
 Page, Janet "Vixen"9,17,18
- PANNING CONTROL**
 FLIGHT49
- Parker, Billy "Prime Time"10,14,
 17,19,21
- Partial installation option54
- Petrie, Anton18-21
- Phoenixsee Forrester
- Pipper.....see dogfight sight reticle
- Pitch58,66,68,69
 ladder (HUD).....58,60
- Player-to-target camera.....51
- Predictor gunsightsee dogfight mode
- Prideaux, Jean-Paul "Jackal" ..3,13,
 34-35,36-38,39
- Prime Timesee Parker
- Pull-up warning59
- Pure pursuit70
- Pursuit70,76
- Q**
 QUIT TO DOS (saved game).....54

R

Radar	
air-to-air MFD	64
air-to-ground MFD	64
lock	76
lock warning	58,65
Rail	see hardpoints
Range to target	see target
RAW scope	see threat warning indicator
Redout	67
RESTART	
EXIT GAME	48
RESUME (saved game)	54
Reticle	see strafe reticle and dogfight reticle
Return to startup menu	47
Return to Wildcat base	
from Selim's	57
from Strike base	57
Richards, Lyle "Baseline"	8,12, 15-16,35
Right cockpit camera	51
Rocket pods	63,75,77
Rockeye	see Mk20
Roll	66,68,69
angle	58
lag	see lag roll
ROOKIE	
CONFIGURATION	48
dogfight training mission	47
GAMEPLAY/ENEMY INTELLIGENCE	49
Rotation	68
Rudder	63,66,68,69,75,77
Runways	75
DETAIL/TERRAIN	49

S

SAM	65,75,78
SAVE	
barracks or tent	46,52,54,56
CONFIGURATION	48
Schraeder, Miguel "Zorro"	7,14, 17,18,19
SEARCH AND DESTROY	
(training mission)	47,77
SECOND JOYSTICK	
FLIGHT/PANNING CONTROL	49
Selected weapon indicator	
see weapons	
Selim's	3,13,15-17,36,52,57
Sentry AWACS	see E-3
Shaking hands	57
Shiloh, USS	8,16,34
SHOW WEAPONS	
FLIGHT	49
Sidewinder	see missiles (short range)
Single target tracking mode	64
Sleeping pilot	54
Slot	77
SMALL	
CAMERAS/WINDOW SIZE	49

SMART RADAR	
COCKPIT	50,64
SMART RAW SCOPE	
COCKPIT	50
SMART TARGETING	
COCKPIT	50
SOUND FX	
AUDIO	50
SPEECH	
AUDIO	50
SRM diamond (HUD)	60
Stalls	69
FLIGHT	49
and camera views	50
warning	59
START NEW GAME	46
Startup menu	46
returning to	47
Stern, James "Hawk"	3,6,7,8, 13,14,15,17,18,34-35,36-38
Strafe mode	62
reticle (HUD)	60,62
Strike base	56
Su-27	77,78,84
SUN GLARE	
COCKPIT	50
T	
Taking off	68
Talking	52
TAPES	
COCKPIT	50
Target	60,61,67
friendly (HUD)	60,61
range to (HUD)	60,61
Target aspect angle	70,73
air-to-air radar MFD	64
circle and caret (HUD)	60,61,62
Target-to-player camera	51
Tent (Strike base)	46,56
TERRAIN	
DETAIL	49
TERRAIN IN GUN CAMERA	
CAMERAS	49
Tex	see Travis
TEXTURE	
DETAIL/OBJECTS	49
Threat warning indicator	65
360° LOCK	
COCKPIT	50
360° RADAR	
COCKPIT	50,64
Throttle	68,69,82
HUD	58,59
and Communications MFD	63
Thrust	66
Thrustmaster	68
THRUSTMASTER (FLIGHT/CONTROL)	49
FLIGHT/PANNING CONTROL	49
Thunderbolt	see A-10
Time burst	50
Time compression	50
Tornado	85
TRAINING MISSION	46,47,69,76

TRANSITION

DETAIL/TERRAIN	49
Transport truck	see truck
Travis, Clayton "Tex"	10,12,15,17
Troubleshooting	see Install Guide
Truck (to/from Strike base)	52,56
Tu-20	87
Tu-95	see Tu-20
Turkish Diplomatic Forces	42
Turn radius	70
TWI	see threat warning indicator

U

UNLIMITED AMMO	
GAMEPLAY	49

V

Velocity vector (HUD)	58
VETERAN	
CONFIGURATION	48
dogfight training mission	47
GAMEPLAY/ENEMY INTELLIGENCE	49
VIEW OBJECTS	46
Victim camera	51
VICTIM VIEW	
CAMERAS	49
Virgil	see Beetlebaum
Virgil's office	see office
Vixen	see Page
Vulcan	61,73,75,76

W

Warthog	see A-10
Waterline	64
Waypoint	
caret (HUD)	58,59
distance to	58,59
Weapon camera	51,77
WEAPONS	
CAMERAS	49
buying	55
packages	55
loading	53,67
MFD	63
remaining	60,61,63
selected (HUD)	60,61,76
selected mode (HUD)	60,67
Wildcats	3,6,12-21, 34-35,36-38,52,78
base	52
WINDOW SIZE	
CAMERAS	49

Y

Yaw	66,68
YF-22	see F-22
YF-23	86
Yo-yo	see high yo-yo and low yo-yo

Z

ZOOM	
VIEW OBJECTS	47
Zorro	see Schraeder

STRIKE COMMANDER CREDITS

Programming

RealSpace™ system	Jason Templeman, Chris Roberts, Paul Isaac
Graphic primitives	Paul Isaac, Chris Roberts, Miles Design
Flight models	Arthur DiBianca, Jason Templeman
Computer intelligence	Jason Yenawine, Jason Templeman, Frank Savage
Cockpit, HUD and MFDs	Frank Savage, Jason Templeman, Bill Baldwin, Thomas Blom, Arthur DiBianca, Chris Roberts, Paul Isaac
Weapon systems	Frank Savage, Jason Templeman
Mission system	Paul Isaac, Frank Savage
Cameras	Chris Roberts
Visual effects	Chris Roberts
Audio system	Bill Baldwin, Miles Design
RealSpace terrain editor	Frank Savage, Bill Baldwin
RealSpace object editor	Paul Isaac
Option scenes	Arthur DiBianca, Bill Baldwin
Cinematic sequences	Richard Johnson, Arthur DiBianca, Bill Baldwin
Install program	Scott Biggs
JEMM	Jason Yenawine
NIM system programming	Scott Biggs
Library code	Jeff Wilson, Zach Simpson, Will McBurnett, Phil Sulak, Chris Roberts, Paul Isaac, Jason Yenawine, Bill Baldwin
Additional programming	Eric Hyman
Technical consultant	Greg Passmore
Simulation consultants	Karl "Orca" Kuschner Karl "Dr. K" Heinz

Audio

Flight music	Nenad Vugrinec, Dana Glover
Cinematic music	Dana Glover, Marc Schaeffgen, Randy Buck
Option scene music	Nenad Vugrinec
Ad Lib music conversion	Kirk Winterrowd, Nenad Vugrinec
Additional music	Martin Galway
Sound effects	Nenad Vugrinec, John Tipton, Kirk Winterrowd
Digital processing software	Martin Galway, Jeff Wilson
Digital sampling/effects	Randy Buck
NIM system design	Nenad Vugrinec, Martin Galway



We create worlds.
An Electronic Arts® Company

Voices

The Hero	Jason Tirado
Stern	Richard Jones
Tex	Marco Perella
Miguel	Celso Martinez
Lyle	Tom Byrne
Billy	Christina Gerard
Gwen	Lucinda Hinton
Virgil	Don Phillips
Prideaux	Jean-Marc Chemla
Janet	Tonie Perensky
Walters	Joshua Blyde
Mendez	Harry Porter
Thug in alley	Richard Mather
Drunk	Craig Halverson
Informant	Bruce Lemmons
On Board Warning System	Norma J. Vargas

Artwork

3-D studio sets and meshes	Bruce Lemmons, Danny Garrett, Chris Douglas, Jake Rodgers
Cinematic animations	Bruce Lemmons, Craig Halverson, Chris Douglas, Denis Loubet, Jake Rodgers
Backgrounds	Craig Halverson, Bruce Lemmons, Denis Loubet
Character animations	Craig Halverson, Chris Douglas, Denis Loubet, Danny Garrett
Menus and fonts	Bruce Lemmons
RealSpace terrain textures	Craig Halverson
RealSpace buildings	Bruce Lemmons, Paul Steed
RealSpace planes and vehicles	Paul Steed
Documentation Graphics	Paul Steed

Packaging

Box design	Craig Miller, Jennifer Davis
Documentation	Tim Ray, Rob Irving, Prem Krishnan
Editing	David Ladyman, Carolyn Cutler
Graphic design	Jennifer Davis

Design

Original outline	Chris Roberts and Jeff George
Screenplay	G. P. Austin
Gameflow	Robert Irving
Additional conversations	Robert Irving
Map design and layout	Tim Ray
Mission design	Tim Ray, G. P. Austin, Jason Templeman, Chris Roberts
Mission layout	Prem Krishnan, Robert Irving, Tim Ray
Vehicle, weapon and plane data	Tim Ray
Associate producer	Erin Roberts
Produced by	Chris Roberts
Directed by	Chris Roberts

©1993 Origin Systems, Inc. Strike Commander and RealSpace are trademarks of Origin Systems, Inc. ORIGIN and We create worlds are registered trademarks of Origin Systems, Inc. Electronic Arts is a registered trademark of Electronic Arts.

ORIGIN Systems, Inc. LIMITED 90 DAY WARRANTY.

ORIGIN warrants to the original purchaser of this computer software product that the recording medium on which the software programs are recorded will be free from defects in material and workmanship for 90 days from the date of purchase.

If the recording medium is found defective within 90 days of original purchase, ORIGIN agrees to replace, free of charge, any such product upon receipt at its Factory Service Center of the product, postage paid, with proof of date of purchase. This warranty is limited to the recording medium containing the software program originally provided by ORIGIN. This warranty shall not be applicable and shall be void if the defect has arisen through abuse, mistreatment or neglect. Any implied warranties applicable to this product are limited to the 90-day period described above. If failure of the software product, in the judgment of ORIGIN, resulted from accident, abuse, mistreatment or neglect, or if the recording medium should fail after the original 90-day warranty period has expired, you may return the software program to ORIGIN, at the address noted below, with a check or money order for \$5.00 (U.S. currency), which includes postage and handling, and ORIGIN will mail a replacement to you. To receive a replacement, you should enclose the defective medium (including the original product label) in protective packaging accompanied by: (1) a \$5.00 check (2) a brief statement describing the defect and (3) your return address. Canada and Foreign Orders Note: Only U.S. money orders are accepted.

Except as set forth above, this warranty is in lieu of all other warranties, whether oral or written, express or implied, including any warrant of merchantability or fitness for a particular purpose, and no other representation of claims of any nature shall be binding on or obligate ORIGIN. In no event will ORIGIN be liable for special, incidental or consequential damage resulting from possession, use or malfunction of this product, including damage to property and to the extent permitted by law, damages for personal injury, even if ORIGIN has been advised of the possibility for such damages. Some states do not allow limitations on how long an implied warranty lasts and/or the exclusion or limitation of incidental or consequential damages, so the above limitation and/or exclusion or limitation of liability may not apply to you. This warranty gives you specific legal rights. You may have other rights that vary from state to state.

ONLINE SERVICES AND BULLETIN BOARDS

Today's online services open up exciting new worlds to anyone with a modem and communications software. You can shop in electronic malls, play games, participate in special interest forums, make flight reservations and see the latest stock market quotes. You can view up-to-the-minute news and weather, subscribe to an electronic mail service and access information stored in hundreds of newspapers, magazines and other periodicals and databases. And that just scratches the surface.

Many of the most popular online services provide access to ORIGIN company news, product updates, release dates, technical support and game hints. In addition, ORIGIN has established its own electronic bulletin board as a customer service.

If you already subscribe to an online service, the following information will guide you to the ORIGIN sections. If you're looking for more information about online services, phone numbers are also listed below.

America Online: You can e-mail Customer Support at ORIGIN CS or Marketing at OSI. To reach our Customer Support board in the Industry Connection, press IJK for "Go to Keyboard." Then type ORIGIN in the Keyword window. In addition to reading messages, you can download files from the "Origin Software Library." For membership information and a free starter kit, you can call America Online toll-free at 1-800-827-6364.

CompuServe: To reach our Customer Support board in the Game Publishers Forum, type GO GAMEPUB at any "!" prompt. Then select Origin Systems. In addition to reading the messages, you can download files from the "Library (Files)" menu. To reach our Customer Service department by e-mail, our address is 76004,2612. For membership information and a free starter kit, you can call CompuServe toll-free at 1-800-848-8199 and ask Representative #361 for your free introductory membership and \$15 usage credit.

GEnie: You can e-mail Customer Support at ORIGIN. To reach our Customer Support board in the Games RoundTable, Scorpio RT, type M805;1 at any "?" prompt. Then select Origin Systems at Category 16. In addition to reading the messages, you can download files from the "Games RoundTable Libraries." For membership information, you can call GEnie toll-free at 1-800-638-9636.

ORIGIN BBS: The ORIGIN BBS is located in Austin, Texas and has a modem support of: 300/1200/2400/9600 bauds with N,8,1. It is operational 24 hours a day, 7 days a week. Full support is provided. Call 1-512-331-4446 to contact. No membership is required and the only cost is any long distance charges that you may incur.

Internet Address: You can e-mail Origin Customer Support at ORIGIN_CS@AOL.COM or Origin Marketing at OSI@AOL.COM.



**High munition costs got you down?
Need to buy in volume?
Look no further!**

From small arms to air defense nets, Adnan's Place can fill your bill. Volume discounts available! Ask about our monthly theater of operations specials! If it's a weapon, Adnan's has it! Don't wait, call now.

Pyrol Rockets — AMRAAM.

(P.O.#1023 AIM-120 AMRAAM Unit Cost: \$200,000)

The state of the art in Air-to-Air! Twice the range and more than twice the warhead of any Sidewinder! And speed, speed, speed! Remember, with AMRAAM, you don't need to spot 'em to splash 'em! Please allow 4-6 weeks for orders of 30 or more. Free radar integration estimate with first order.

Operators are standing by!

CALL 1-800-555-GUNS.

Fax orders dial 1-800-555-BOOM

Mailing Address:

Adnan's Place
Suite 12-B, Al-Bazad Terrace
Istanbul, Uskudar Province, Turkey

Special this Month!



© Copyright 2011 Adnan's Place.
Adnan and Adnan's Place are registered trademarks of Adnan's Place.

